

# INSTRUCTIONS

## EZPAN® WITH SMARTSHIFT® 1X4, 2X2, 2X4 INSTALLATION



RAB Lighting is committed to creating high-quality, affordable, well-designed and energy-efficient LED lighting and controls that make it easy for electricians to install and end users to save energy. We'd love to hear your comments. Please call the Marketing Department at 888-RAB-1000 or email: [marketing@rablighting.com](mailto:marketing@rablighting.com)



EZPAN 1X4



EZPAN 2X2



EZPAN 2X4

### IMPORTANT

#### READ CAREFULLY BEFORE INSTALLING FIXTURE. RETAIN THESE INSTRUCTIONS FOR FUTURE REFERENCE.

RAB fixtures must be wired in accordance with the National Electrical Code and all applicable local codes. Proper grounding is required for safety. THIS PRODUCT MUST BE INSTALLED IN ACCORDANCE WITH THE APPLICABLE INSTALLATION CODE BY A PERSON FAMILIAR WITH THE CONSTRUCTION AND OPERATION OF THE PRODUCT AND THE HAZARDS INVOLVED.

**WARNING: Make certain power is OFF before installing or maintaining fixture. No user serviceable parts inside.**

**CAUTION: For proper weatherproof function all gaskets must be seated properly and all screws inserted and tightened firmly. Apply weatherproof silicone sealant around the edge of the ceiling mounting box and/or junction box. This is especially important with an uneven ceiling surface. Silicone all plugs and unused conduit entries.**

### SAFETY INSTRUCTIONS

**WARNING:** Risk of fire or electric shock. Suitable for damp locations.

**WARNING:** Suitable for 9/16" or 15/16" flat T-Grid in both insulated ceilings and non-insulated ceilings. Access above ceiling required.

**WARNING:** Do not handle energized fixture when hands are wet, when standing on wet or damp surfaces, or in water.

**WARNING:** Vapor barrier must be suitable for 90° C.

**WARNING:** Fixture to be independently supported to building structure.

### RECESSED CEILING MOUNTING

The fixture is suitable only for INDOOR RECESSED CEILING application. Above ceiling access required.

To mount in an insulated or non-insulated ceiling - 9/16" or 15/16" exposed Flat T-Grid Ceiling follow the steps below.

1. Firmly bend the pre-installed **Grid Clips** (*up and out as shown in Fig. 1*).
2. Rotate and slide the **Fixture** as required to fit through the **T-Grid Bar** and place it as indicated by the directional arrow as shown in Fig. 2. Secure the **Fixture** to the **T-Grid Bar**.
3. Support wires are required by Installation Codes. Support the **Fixture** to the building structure by **Support Wires** (**supplied by others**) through the **Grid Clip Hole** as shown in Fig. 3.
4. Make sure that the orientation of the **Splice Box** and **Access Plate** faces an accessible tile to make electrical splices.

Fig: 1

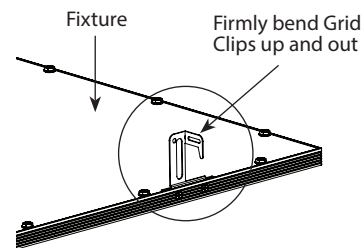

Fig: 2

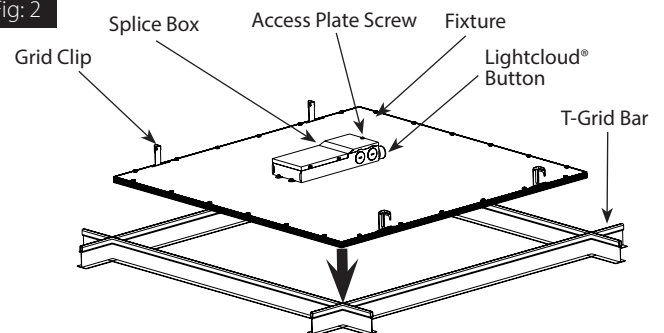
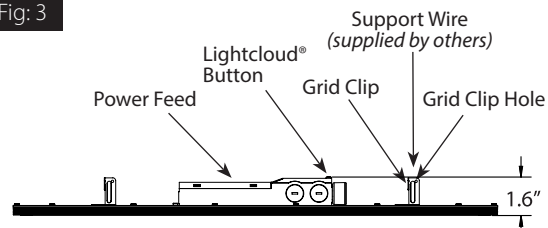

Fig: 3



# INSTRUCTIONS

## EZPAN® WITH SMARTSHIFT® 1X4, 2X2, 2X4 INSTALLATION



RAB Lighting is committed to creating high-quality, affordable, well-designed and energy-efficient LED lighting and controls that make it easy for electricians to install and end users to save energy. We'd love to hear your comments. Please call the Marketing Department at 888-RAB-1000 or email: [marketing@rablighting.com](mailto:marketing@rablighting.com)

### RECESSED CEILING MOUNTING (cont'd)

- Loosen **Access Plate Screw** and remove the **Access Plate**. Knock out appropriate **Conduit Knockouts** on the **Access Plate** to route input conduit. Use appropriate conduit connectors as required by code (Fig. 4).
- Connect wires as shown in wiring diagram. Push all wires back into the **Splice Box**. Use appropriate UL approved wire connectors as required by code to complete wiring. Be careful not to pinch wires. **WARNING: To prevent wiring damage or abrasion, do not expose wiring to edges of sheet metal or other sharp objects.**
- Replace **Access Plate** and tighten **Access Plate Screw**.

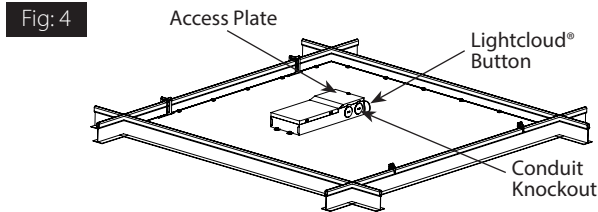

### WIRING

**WARNING:** Lightcloud-enabled fixtures require constant power and shouldn't be placed down circuit from any switching devices.

Universal voltage driver permits operation at 120V thru 277V, 50 or 60 Hz. Follow the wiring directions shown in Fig 5.

- Connect the **Black** fixture lead to the **LINE** supply lead.
- Connect the **White** fixture lead to the **COMMON** supply lead.
- Connect the **GROUND** wire from fixture to supply ground.

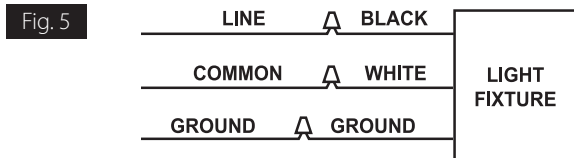

**NOTE:** To test, triple click the Radio Button through all color temperatures shown in Fig 6.

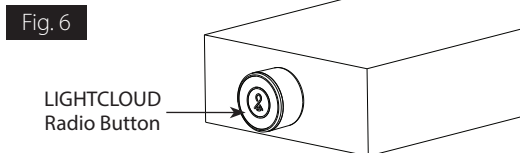

### LIGHTCLOUD® SMARTSHIFT®

Lightcloud SmartShift technology synchronizes fixture color temperature to align with the natural transition of the sun. SmartShift can be enabled and disabled by calling Lightcloud Support at 1.844.LIGHTCLOUD or logging into the Web App at [control.lightcloud.com](http://control.lightcloud.com). Individual SmartShift fixtures can also be manually configured for color temperature.

SmartShift fixtures require a Lightcloud Gateway and should be placed within 100' of another Lightcloud device.

#### LED Indicators:

**Blinking Red** = Looking for a network

**Solid Green** = Connected to network

SmartShift fixtures require a Lightcloud Gateway and should be placed within 100' of another Lightcloud device.

### CLEANING

**CAUTION:** Be sure fixture temperature is cool enough to touch. Do not clean or maintain while fixture is energized.

- Clean glass lens with non-abrasive glass cleaning solution.
- Do not open the fixture to clean the LED. Do not touch the LED.

### TROUBLESHOOTING

- Check that the fixture is powered.
- Check that the line voltage at fixture is correct. Refer to wiring directions.
- Be sure the fixture is grounded properly.
- Call Lightcloud Support at 1.844.LIGHTCLOUD.

**Note:** These instructions do not cover all details or variations in equipment nor do they provide for every possible situation during installation, operation or maintenance.

# INSTRUCTIONS

## EZPAN® WITH SMARTSHIFT® 1X4, 2X2, 2X4 INSTALLATION



RAB Lighting is committed to creating high-quality, affordable, well-designed and energy-efficient LED lighting and controls that make it easy for electricians to install and end users to save energy. We'd love to hear your comments. Please call the Marketing Department at 888-RAB-1000 or email: [marketing@rablighting.com](mailto:marketing@rablighting.com)

# BATTERY BACKUP MODELS

## WIRING

**CAUTION: FOR BATTERY BACKUP FIXTURE.** Voltage can be present in **BATTERY**. Do not join **BATTERY** connector until installation is complete and AC power is supplied to the emergency driver (Fig. #7).

**NOTE:** An **UNSWITCHED** AC source of power is required. The emergency driver must be fed from the same branch circuit as the LED driver.

**CAUTION:** Do not use any supply voltage other than 120-277V 50/60 HZ.

1. Connect **UNSWITCHED HOT** fixture lead to **HOT AC** supply line.
2. If using an **UNSWITCHED** circuit, connect **UNSWITCHED** and **SWITCHED** lines together.
3. If using a **SWITCHED** circuit, connect **SWITCHED HOT** AC fixture lead to the external.
4. Connect the pink (or gray) fixture lead to the (V-) DIM lead.
5. For 0-10V Dimming, connect **DIM (+)** and **DIM (-)** to the supply **DIM (+)** and **DIM (-)**.
6. Connect **Ground** lead from the fixture to the supply ground. Do not connect **Ground** to the output leads.
7. All unused leads must be capped and insulated.
8. Install the **Switch Plate** (along with the charging indicator) in a suitable **Junction Box** (by others) in an adjacent ceiling tile. It should be located nominal 2ft from the fixture.
9. After installation is complete, supply AC power to the fixture and connect the **BATTERY**.
10. When power is on, the fixture should be on and the Charging Indicator Light should illuminate to indicate the battery is charging.
11. Once the **BATTERY** has charged for at least one hour, a short duration test may be performed by pressing the **Test Button** (Fig. 8).
12. After the battery has charged for 24 hours, a long duration test can be performed by shutting power to the fixture.

FIG. #7

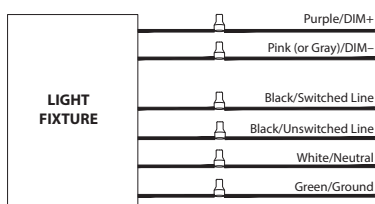

INSIDE FIXTURE

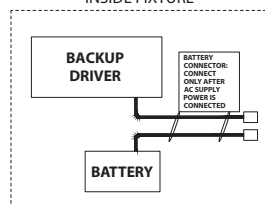

## OPERATION

1. When AC power is applied, the charging indicator light is illuminated, indicating that the **BATTERY** is being charged.
2. When power fails, the standby power automatically switches to emergency power (*internal battery*), operating at reduced illumination. The emergency driver supplies power in standby power for a minimum of 90 minutes.
3. When AC power is restored, the emergency driver automatically returns to charging mode.

## MAINTENANCE

Although no routine maintenance is required to keep the emergency driver functional, it should be checked periodically to ensure that it is working. The following schedule is recommended:

1. Visually inspect the charging indicator light monthly. It should be illuminated.
2. Test the emergency operation of the fixture at 30-day intervals for a minimum of 30 seconds.
3. Conduct a 90-minute discharge test once a year. Fixture will operate at reduced illumination for a minimum of 90 minutes.

## TROUBLESHOOTING

1. Is the fixture grounded properly?
2. If the charging indicator light does not illuminate after pressing the **Test Button**, check if battery is connected properly.
3. Is the Battery Backup Dip Switch Position set to 4?

Battery Backup Setting

PRODUCT	WATTAGE	DIP SWITCH POSITION
EZPAN-SS-1X4	50	4
EZPAN-SS 2X2	50	4
EZPAN-SS-2X4	50	4

FIG. #8

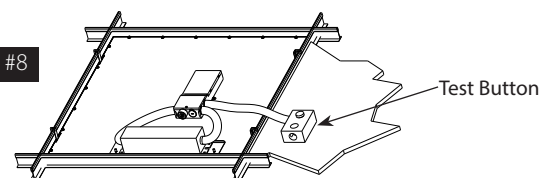

© 2021 RAB LIGHTING Inc.

### Easy Answers

[rablighting.com](http://rablighting.com)  
Visit our website for product info

**Tech Help Line**  
Call our experts: 888 722-1000

**e-mail**  
Answered promptly - [sales@rablighting.com](mailto:sales@rablighting.com)

**Free Lighting Layouts**  
Answered online or by request