

INSTRUCTIONS

TOC TAPE LIGHT INSTALLATION

RAB®

RAB Lighting is committed to creating high-quality, affordable, well-designed and energy-efficient LED lighting and controls that make it easy for electricians to install and end users to save energy. We'd love to hear your comments. Please call the Marketing Department at 888-RAB-1000 or email: marketing@rablighting.com
** DON'T TOSS IT—RECYCLE IT! MAKE THE SUSTAINABLE CHOICE BY RECYCLING THIS FIXTURE AT END OF LIFE WITH A LICENSED RECYCLING PROVIDER. **



TOCYY, TOCY, TOCYN, TOCN, TOCCW

IMPORTANT

READ CAREFULLY BEFORE INSTALLING FIXTURE. RETAIN THESE INSTRUCTIONS FOR FUTURE REFERENCE.

RAB fixtures must be wired in accordance with the National Electrical Code and all applicable local codes. Proper grounding is required for safety. THIS PRODUCT MUST BE INSTALLED IN ACCORDANCE WITH THE APPLICABLE INSTALLATION CODE BY A PERSON FAMILIAR WITH THE CONSTRUCTION AND OPERATION OF THE PRODUCT AND THE HAZARDS INVOLVED.

1. The operation instruction does not supersede federal, state, local, or (*inter*) national laws, regulations, rules, ordinances, and codes that may apply to electrical installations.
2. The installation and electrical connection process must be operated by a professional electrician using the applicable and appropriate electrical codes.
3. Installation, usage and storage must occur in the environment within the temperature range (*usually -20~45°C for installation & usage and -20~60°C for storage*) indicated on the product datasheet of the tape light.
4. Make sure the operating voltage of the tape light coincides with the voltage of the extra LED power supply certified for the LED lighting industry, do not connect the tape light directly to the AC power such as 120V input.
5. Please choose the suitable waterproof rating of the tape light according to the actual application scene.
6. Unroll the tape light from reel before illumination, to avoid product damage caused by the heat.
7. The tape light can be cut into certain shorter lengths, and also can be spliced into longer lengths. Please refer to the standard length and increment written on the product datasheet of the tape light. Beyond working length will lead to quality issues like overload, uneven brightness, etc.
8. Turn off the power supply before wiring, assembly, processing, cleaning, maintenance, etc, and ensure all wiring and polarities are correct before powering on.
9. Do not secure the tape light with staples, nails, or similar objects that can damage the insulated housing for waterproofing.
10. Be aware of ESD protection, handle with care without colliding or crushing, do not mechanically press down on LED and other components, and do not cover the tape light with heat insulation gasket material.
11. Try to use in a well ventilated environment and avoid complete sealing. Avoid installing and using the tape light near heat sources, or other potentially dangerous sources like corrosive solvents.
12. To protect your eyes, do not stare at the light for a long time when illuminating the tape light.
13. An additional heat sink is helpful for the heat conductivity and LED lifetime, please refer to the heat sink and LED lifespan definition on the product datasheet of the tape light.
14. To reduce the voltage drop as much as possible, the wire length between tape light and power supply should be as short as possible.
15. Considering the reliability of the LED power supply, it's recommended to use the loading powers not exceed 80% of its rated output power.
16. Make sure that the LED power supply does not generate reverse voltage, it will damage the tape light.
17. Dust and dirt accumulated over time should be removed from the light emitting surface to assure optimal functioning of the tape light. Disconnect the power before maintenance and cleaning.
18. Paints, solvents and corrosive cleaning chemicals may not contact and thus affect the tape light.
19. This product may not be treated as household waste, dispose of the material through the waste recycling of electrical and electronic equipment.
20. CAUTION: The mounting means provided with this tape light has not been evaluated for reliability. If installed where failure of the mounting means could cause injury to persons or damage to property below, supplemental means of securement should be considered.

INSTRUCTIONS

TOC TAPE LIGHT INSTALLATION

RAB®

RAB Lighting is committed to creating high-quality, affordable, well-designed and energy-efficient LED lighting and controls that make it easy for electricians to install and end users to save energy. We'd love to hear your comments. Please call the Marketing Department at 888-RAB-1000 or email: marketing@rablighting.com
** DON'T TOSS IT—RECYCLE IT! MAKE THE SUSTAINABLE CHOICE BY RECYCLING THIS FIXTURE AT END OF LIFE WITH A LICENSED RECYCLING PROVIDER. **

WARNING



SHOCK HAZARD!
IT MAY RESULT IN SERIOUS INJURY OR DEATH!
Do not connect the tape light directly to the high voltage power.
Please turn off the power prior to installation.

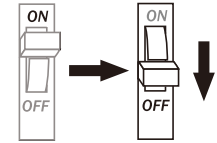
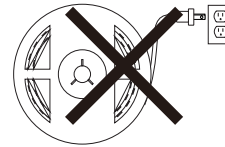

HANDLE PRODUCT WITH CARE!

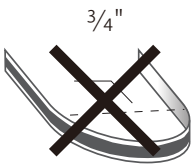

Do not bend the tape light to a radius less than 0.79 inches. In addition, the bending position should avoid electronic components to prevent damage.



Do not bend the tape light on a horizontal plane.



Do not cover the tape light with any materials.



Do not fold, crease the tape light.



Do not pull the tape light or driver wire hard during installation and using.

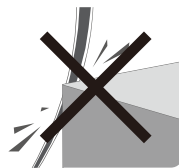

Do not rub the tape light with other objects.



Do not twist the tape light.



Do not put excessive pressure on surface of the tape light (*glass/acrylic panes, etc.*)

INSTRUCTIONS

TOC TAPE LIGHT INSTALLATION

RAB®

RAB Lighting is committed to creating high-quality, affordable, well-designed and energy-efficient LED lighting and controls that make it easy for electricians to install and end users to save energy. We'd love to hear your comments. Please call the Marketing Department at 888-RAB-1000 or email: marketing@rablighting.com
** DON'T TOSS IT—RECYCLE IT! MAKE THE SUSTAINABLE CHOICE BY RECYCLING THIS FIXTURE AT END OF LIFE WITH A LICENSED RECYCLING PROVIDER. **

INSTALLATION

Option 1: Fixed by 3M tape

1. Clean the mounting surface by removing any dirt, debris, or moisture.

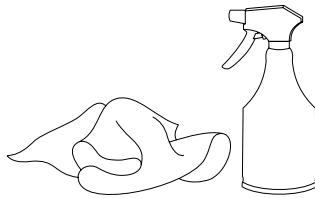

2. Peel off the release paper of the adhesive tape, and then stick the LED tape light to the mounting surface, with materials such as glass, aluminum, iron, stainless steel, PC etc. (Not recommended to stick to low surface energy materials with oil/dust/wax/powder/paint, such as cement, gravel, silicon rubber, rough board etc.)

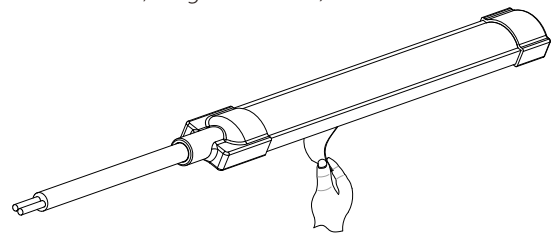

Option 2: Fixed by aluminum bracket and screw in TB12.

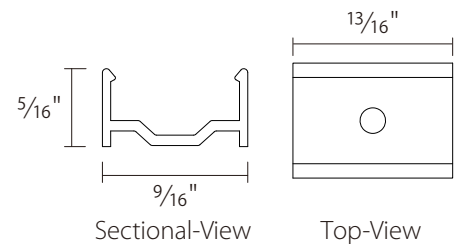
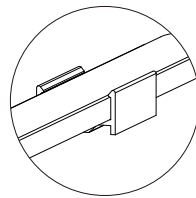
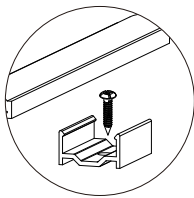

Option 3: Fixed by aluminum profile and screw in TAP14.

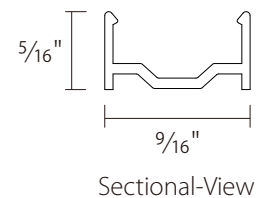
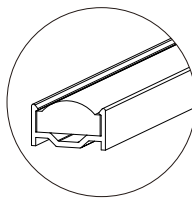
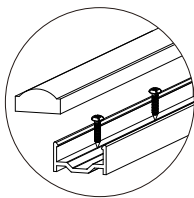

INSTRUCTIONS

TOC TAPE LIGHT INSTALLATION



RAB Lighting is committed to creating high-quality, affordable, well-designed and energy-efficient LED lighting and controls that make it easy for electricians to install and end users to save energy. We'd love to hear your comments. Please call the Marketing Department at 888-RAB-1000 or email: marketing@rablighting.com
** DON'T TOSS IT—RECYCLE IT! MAKE THE SUSTAINABLE CHOICE BY RECYCLING THIS FIXTURE AT END OF LIFE WITH A LICENSED RECYCLING PROVIDER. **

INSTALLATION (cont'd)

Option 4: Fixed by paster-in aluminum profile and screw in TAP16TL.

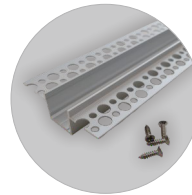
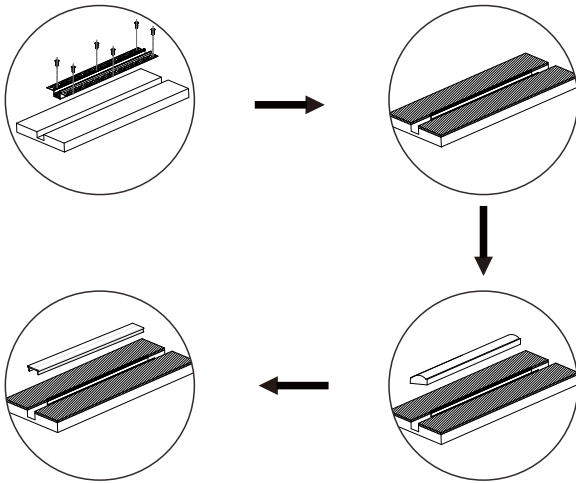

Space & Groove are shown as below
Depth of the plastering layer

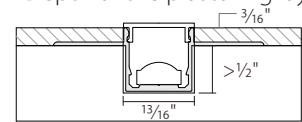

Recessed mounting

Note: Silver color is standard.

INSTRUCTIONS

TOC TAPE LIGHT INSTALLATION



RAB Lighting is committed to creating high-quality, affordable, well-designed and energy-efficient LED lighting and controls that make it easy for electricians to install and end users to save energy. We'd love to hear your comments. Please call the Marketing Department at 888-RAB-1000 or email: marketing@rablighting.com
**** DON'T TOSS IT—RECYCLE IT! MAKE THE SUSTAINABLE CHOICE BY RECYCLING THIS FIXTURE AT END OF LIFE WITH A LICENSED RECYCLING PROVIDER. ****

WIRING for TOCYY, TOCY, TOCYN, TOCN, TOCCW

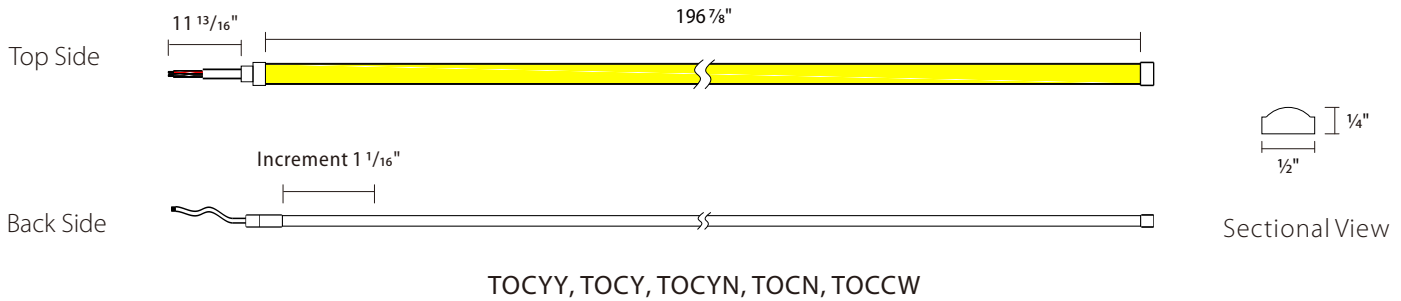

Option 1: use TID-60 or TID-96 driver with TRIAC dimming for static white tape lights for indoor application.

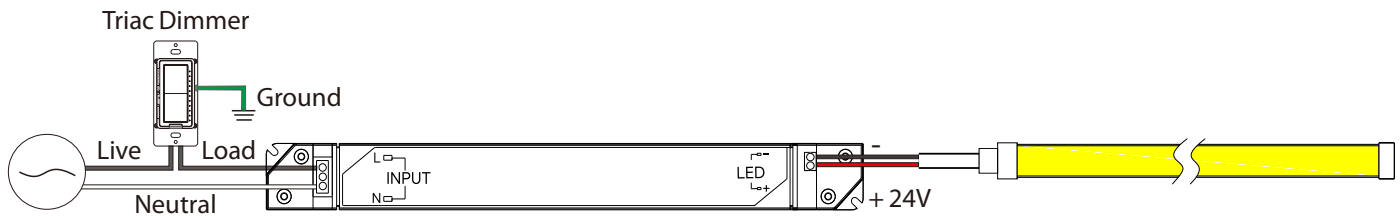

Wire Specification		Value
Input Wire	Gauge	16-20 AWG
Output Wire	Gauge	18-22 AWG

Notes:

- This driver is compatible with both leading edge and trailing edge triac dimmer.
- This driver should be installed by qualified and professional person.
- Please make sure the driver is installed in ventilation environment for good heat dissipation.
- For avoiding driver damage, please make sure the electric wiring is correct before testing.

INSTRUCTIONS

TOC TAPE LIGHT INSTALLATION



RAB Lighting is committed to creating high-quality, affordable, well-designed and energy-efficient LED lighting and controls that make it easy for electricians to install and end users to save energy. We'd love to hear your comments. Please call the Marketing Department at 888-RAB-1000 or email: marketing@rablighting.com
** DON'T TOSS IT—RECYCLE IT! MAKE THE SUSTAINABLE CHOICE BY RECYCLING THIS FIXTURE AT END OF LIFE WITH A LICENSED RECYCLING PROVIDER. **

WIRING for TOCY, TOCY, TOCYN, TOCN, TOCCW

Option 2: use TOD-96 driver with TRIAC dimming for static white tape lights.

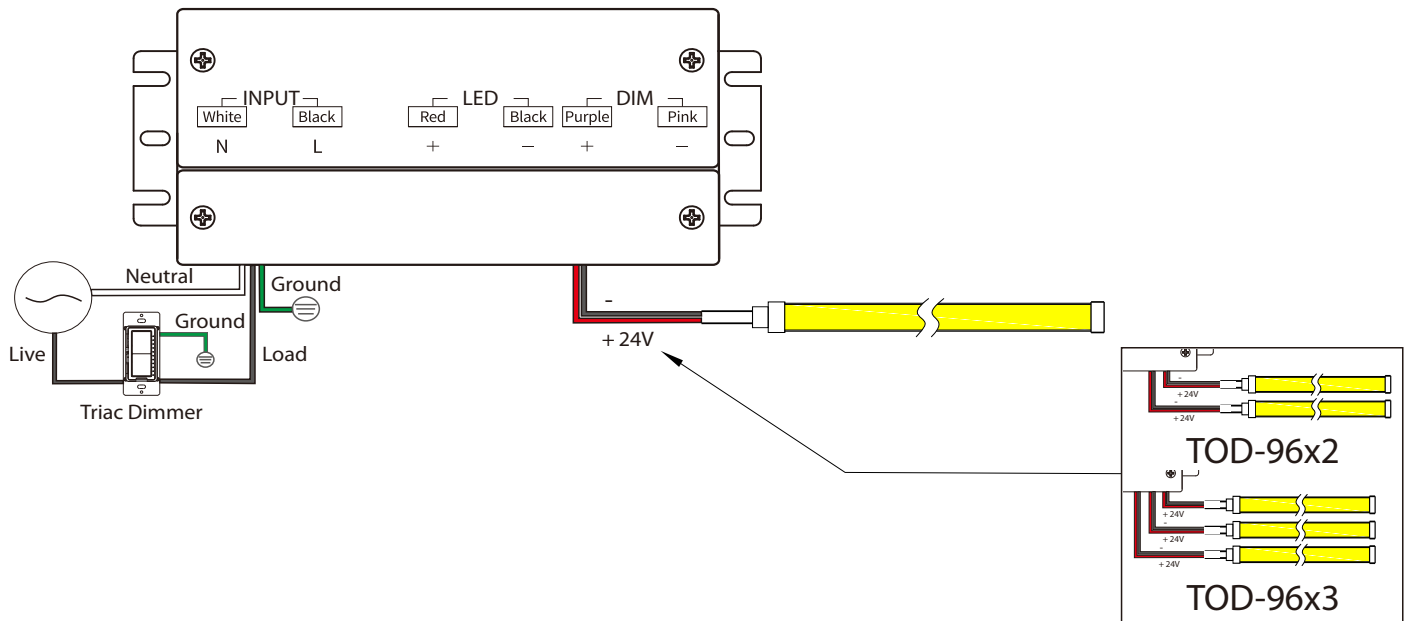

Notes:

- This driver is compatible with both leading edge and trailing edge triac dimmer.
- This driver should be installed by qualified and professional person.
- Please make sure the driver is installed in ventilation environment for good heat dissipation.
- For avoiding driver damage, please make sure the electric wiring is correct before testing.
- Although the waterproof level of the LED driver can reach the wet location in IP65, considering the safety of wiring, it is required that the LED driver should not be directly exposed to outdoor environments that are soaked in rain or water, and should be shielded, such as being placed in a power box.

INSTRUCTIONS

TOC TAPE LIGHT INSTALLATION

RAB®

RAB Lighting is committed to creating high-quality, affordable, well-designed and energy-efficient LED lighting and controls that make it easy for electricians to install and end users to save energy. We'd love to hear your comments. Please call the Marketing Department at 888-RAB-1000 or email: marketing@rablighting.com
**** DON'T TOSS IT—RECYCLE IT! MAKE THE SUSTAINABLE CHOICE BY RECYCLING THIS FIXTURE AT END OF LIFE WITH A LICENSED RECYCLING PROVIDER. ****

WIRING for TOCYY, TOCY, TOCYN, TOCN, TOCCW

Option 3: use TOD-96 driver with 0-10V/1-10V/10V PWM/Potentiometer dimming for static white tape lights.

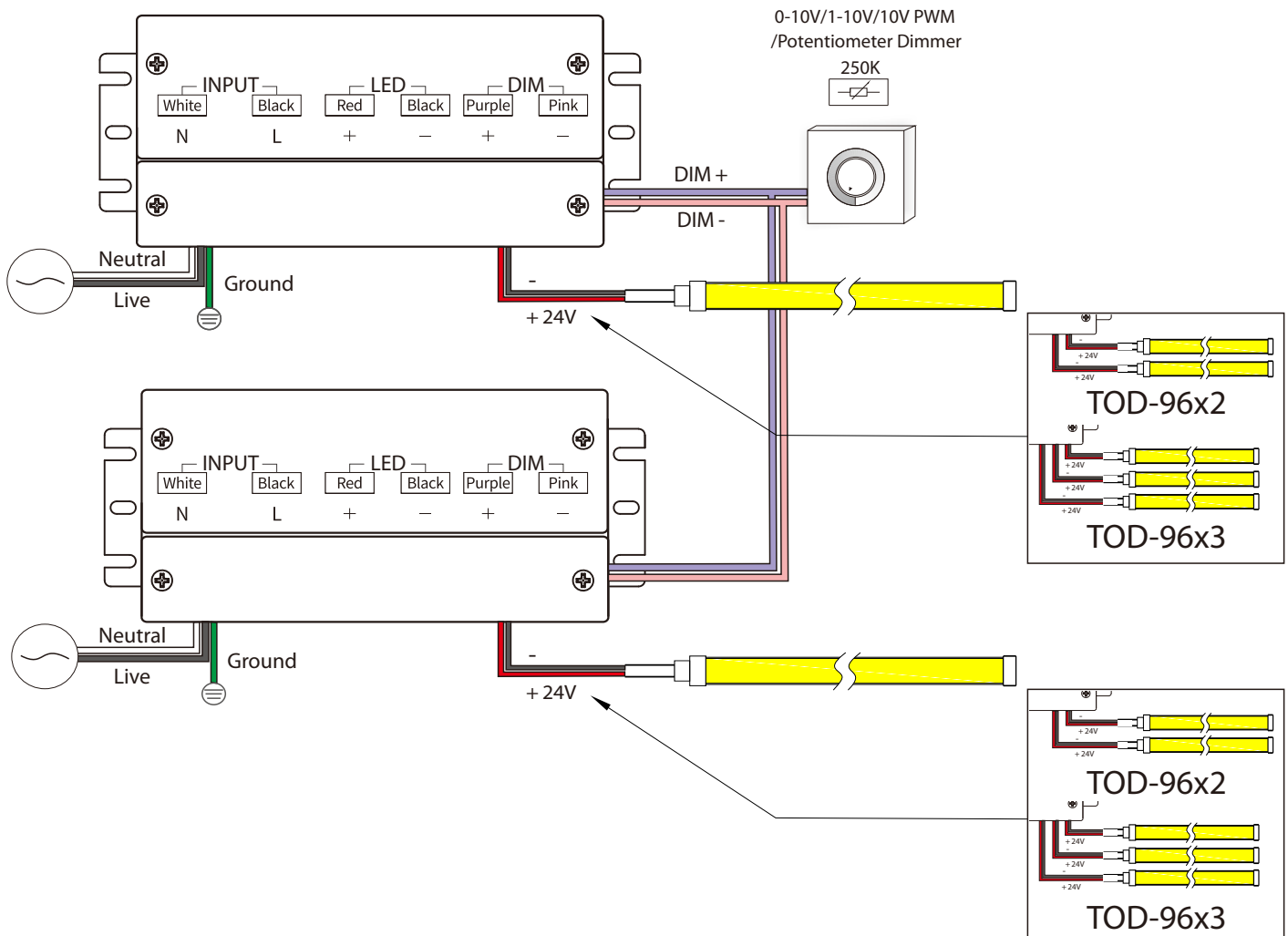

Notes:

- Dimming interface characteristics: 0.9V and below are closed, 1V is the darkest, 10V is the brightest, 1-10V is the dimming range.
- The dimming interface distinguishes between positive and negative, DIM+ is positive, DIM- is negative, please do not reverse.
- Dimming interface does not support voltage access higher than 20V, otherwise it will cause damage to the internal components.
- When the dimming interface is open, the driver outputs the maximum current. When the interface is short-circuited, the current output is closed.
- When multiple synchronous dimming is required, the positive poles of the dimming interface of each driver are connected together, and the negative poles are connected together.
- Support passive dimmer or isolated active dimmer dimming, does not support non-isolated active dimmer dimming.
- In general, it is recommended that the number of drivers connected in parallel under the same dimmer does not exceed 30pcs, and the Max. wiring length of dimming wires do not exceed 328ft.
- It is recommended that the dimming wires should not be lower than the 22AWG wire.
- Do not put the dimming wires with high voltage or interference sources. If it is unavoidable, please use the shielded wires.
- Although the waterproof level of the LED driver can reach the wet location in IP65, considering the safety of wiring, it is required that the LED driver should not be directly exposed to outdoor environments that are soaked in rain or water, and should be shielded, such as being placed in a power box.

INSTRUCTIONS

TOC TAPE LIGHT INSTALLATION

RAB®

RAB Lighting is committed to creating high-quality, affordable, well-designed and energy-efficient LED lighting and controls that make it easy for electricians to install and end users to save energy. We'd love to hear your comments. Please call the Marketing Department at 888-RAB-1000 or email: marketing@rablighting.com
** DON'T TOSS IT—RECYCLE IT! MAKE THE SUSTAINABLE CHOICE BY RECYCLING THIS FIXTURE AT END OF LIFE WITH A LICENSED RECYCLING PROVIDER. **

ASSEMBLY

Option 1: Terminal is sealed with end cap by gluing process.

1. Cut off the silicone part in 0.12in. length.

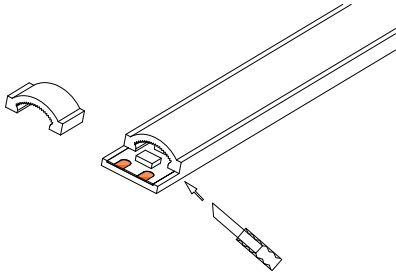

2. Put the front cap through the cable, and then solder the cable to the solder pad on top side.

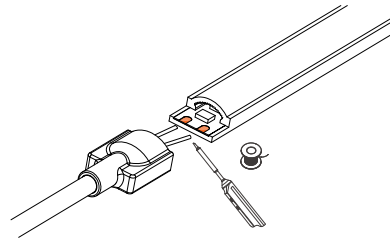

3. Fill the front cap with glue.

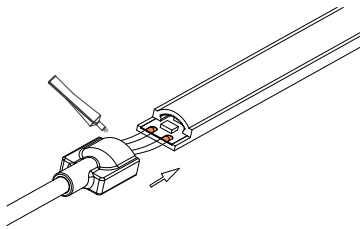

4. Fill the end cap with glue.

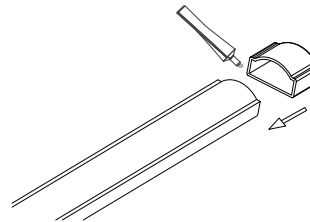

Option 2: Terminal is sealed with quick-assembly connector.

1. Insert the power cable with conductive plate into the bottom of the PCBA and leave 0.08in. outside.

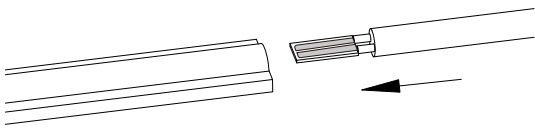

2. Fix the strip light on the lower cover.

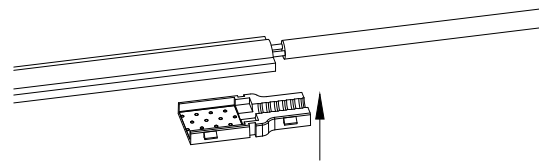

3. Apply an appropriate amount of glue to the reserved 0.08in. slot and fill the grooves and gaps.

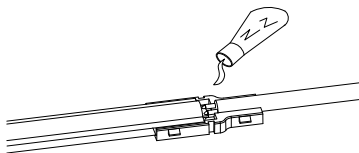

4. Put the upper cover onto the bottom cover.

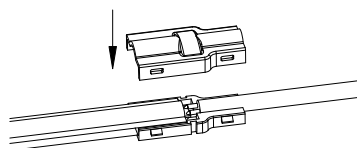

5. Fasten the upper cover to the lower cover by plier, until the buckle is installed in place.

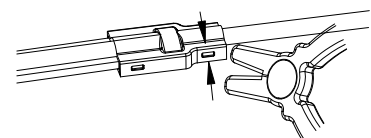

INSTRUCTIONS

TOC TAPE LIGHT INSTALLATION

RAB®

RAB Lighting is committed to creating high-quality, affordable, well-designed and energy-efficient LED lighting and controls that make it easy for electricians to install and end users to save energy. We'd love to hear your comments. Please call the Marketing Department at 888-RAB-1000 or email: marketing@rablighting.com
** DON'T TOSS IT—RECYCLE IT! MAKE THE SUSTAINABLE CHOICE BY RECYCLING THIS FIXTURE AT END OF LIFE WITH A LICENSED RECYCLING PROVIDER. **

ASSEMBLY

For The Extension Connector In The Middle

1. Insert the conductive connection plate into the bottom of the PCBA of the two strip lights, and make sure they are tightly fitted.

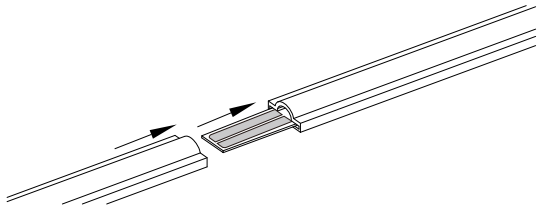

2. Apply a suitable amount of glue to fill the area around the cut gaps.

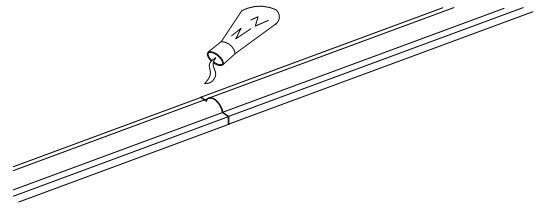

3. Fix the strip light on the lower cover and center it.

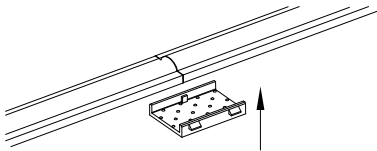

4. Put the upper cover onto the bottom cover.
(For better waterproofing, apply some glue to the gap before installing the upper cover.)

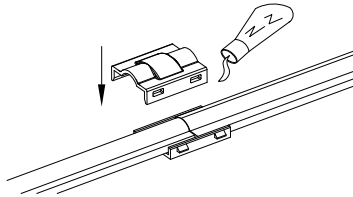

5. Fasten the upper cover to the lower cover by plier, until the buckle is installed in place.

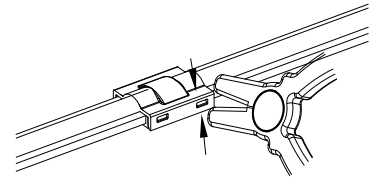

For The End Cap At The Tail

1. Fill the end cap with glue.

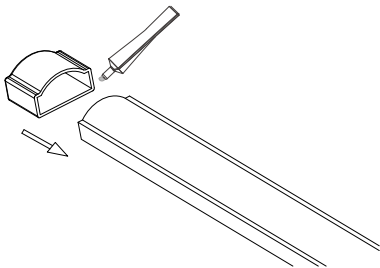

Note : After assembling all glued areas, let stand for 2 hours to allow the glue to fully cure.

INSTRUCTIONS

TOC TAPE LIGHT INSTALLATION



RAB Lighting is committed to creating high-quality, affordable, well-designed and energy-efficient LED lighting and controls that make it easy for electricians to install and end users to save energy. We'd love to hear your comments. Please call the Marketing Department at 888-RAB-1000 or email: marketing@rablighting.com
**** DON'T TOSS IT—RECYCLE IT! MAKE THE SUSTAINABLE CHOICE BY RECYCLING THIS FIXTURE AT END OF LIFE WITH A LICENSED RECYCLING PROVIDER. ****

Accessory Compatibility List

Tape Light Family	Acc CAT Nos	Acc Description
TOC	TPF2OC	2pin Outdoor PCB W=10mm connector kits
	TSG	Silicon glue 10ml per unit, for TPF or TOJ or TOCJ
	TB12	12mm wide mounting brackets for TOC W12*H6mm
	TAP14	12mm wide profile for TOC W12*H6mm
	TOCJ2	2pin connectors for TOC W12*H6mm
	TAP16TL	Trimless 16mm inner wide recessed aluminum profile
	TID-60	60W indoor driver <i>(for indoor only)</i>
	TID-96	96W indoor driver <i>(for indoor only)</i>
	TID/B	J-box for TID Drivers
	TOD-96	96W outdoor LED driver 5in1 dimming
	TOD-96x2	96Wx2 outdoor LED driver 5in1 dimming
	TOD-96x3	96Wx3 outdoor LED driver 5in1 dimming

Easy Answers