

Welcome



Lightcloud®

RGBW Edge-Lit Wafer

WFR4B/RGB

WE'RE HERE TO HELP:

1(844) LIGHTCLOUD

1(844) 544-4825

Hello

Lightcloud Blue is a Bluetooth mesh wireless lighting control system that allows you to control RAB's various compatible devices. With RAB's patent-pending Rapid Provisioning technology, devices can be quickly and easily commissioned for residential and large commercial applications using the Lightcloud Blue mobile app. Each device in a system can communicate with any other device, eliminating the need for a Gateway or Hub and maximizing the control system's reach.

Product Features

- Direct Connect LED, No Gateway or Hub required
- Wireless control from your mobile device
- On/off and dimming
- Tunable RGB, 2700K - 6500K
- Group devices together
- Create custom scenes
- Sensor compatible
- Schedules and automations
- SmartShift™ automated circadian schedule

Catalog Number:

WFR4B/RGB

Model Number:

WFR4B/RGB

Electrical:8W, 550lm
120Vac, 60Hz**Construction:**Installation: Direct Wire
Size: 4"
Trim Finish: White
Trim Style: Baffle

Safety Information

- Not suitable for use with dimmers and sensors unless specifically designed for RAB Lightcloud Blue downlights.
- Risk of electrical shock. Disconnect power at fuse or circuit breaker before installing or servicing.
- No user serviceable parts inside. To avoid electrical shock do not disassemble product.
- This device is not intended for use with emergency exits.
- Type IC. INHERENTLY PROTECTED
- THIS PRODUCT MUST BE INSTALLED IN ACCORDANCE WITH THE APPLICABLE INSTALLATION CODE BY A PERSON FAMILIAR WITH THE CONSTRUCTION AND OPERATION OF THE PRODUCT AND THE HAZARDS INVOLVED.

Risk of fire or electric shock

- Installation requires knowledge of luminaires electrical systems. If not qualified, do not attempt installation. Contact a qualified electrician.

WE'RE HERE TO HELP:

1 (844) LIGHTCLOUD

1 (844) 544-4825

support@lightcloud.com

What's in the box



Fixture (1)

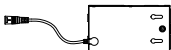

Driver box (1)



Template (1)

Tools needed

This Lightcloud Blue Edge-Lit Wafer requires very few tools for installation. A screwdriver and a pair of wirecutters will help to install.



Optional accessories

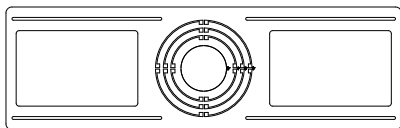

DLPLATE/WFR3456

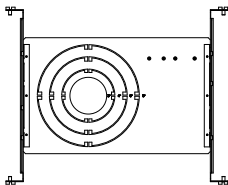

DLPLATE/WFR3468/NB
Mounting plate with nailer bar

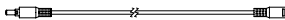

- EXTCBL-FA-6
Wafer extension cable 6ft
- EXTCBL-FA-12
Wafer extension cable 12ft
- EXTCBL-FA-20
Wafer extension cable 20ft

Installing your Lightcloud Blue Device

① Turn off power

- Place the wall switch in the off position.
- Turn off the main power at the breaker panel or remove the fuse from the fuse box.

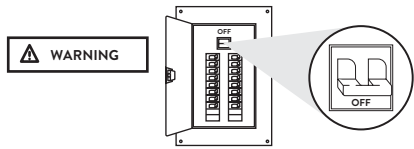

1a Find a suitable location

- Lightcloud Blue devices should be positioned within 60 ft. of each other.
- Building materials such as brick, concrete and steel construction may require additional Lightcloud Blue devices to extend around an obstruction.

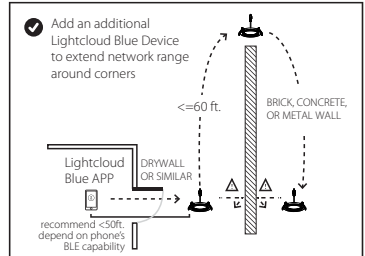

② Install the Lightcloud Blue Edge-Lit Wafer

1. Turn power OFF from the electrical panel before installation.
2. Use template inside box to cut hole in ceiling. (Fig.1)
3. Open the driver box and remove the knockout(s). (Fig.2)

Fig. 1

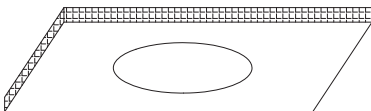
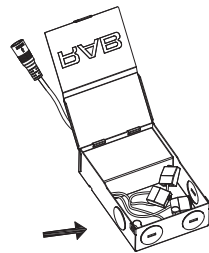

Fig. 2



Installing your Lightcloud Blue Device *(cont'd)*

4. Insert the electrical supply cable through the knockout and secure with attached terminal. Wire driver box (Fig.3), white - white, black - black, green - green/ground.
5. Place all wiring and connections back into the box, close the cover. (Fig.4)

Fig: 3

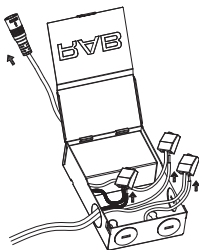
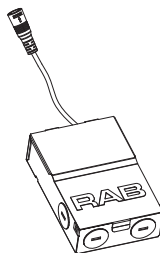

Fig: 4



6. Place the driver box into the ceiling and connect the fixture to driver box. (Fig.5)
7. Lifting both retention tabs upward. Push until the trim sits flush against the ceiling. (Fig.6)

Fig: 5

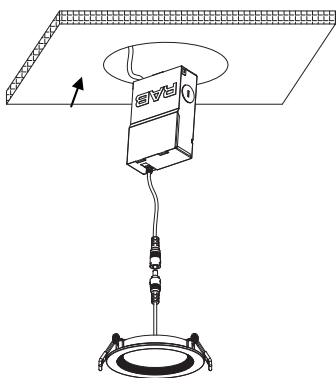
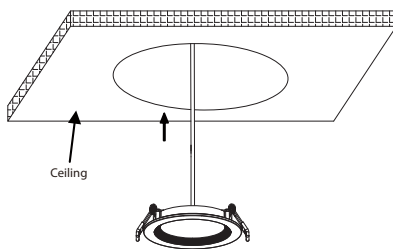

Fig: 6



Controlling your Lightcloud Blue Device

- 1 Confirm your device is powered on.
- 2 Download the Lightcloud Blue app from the Apple® App Store or Google® Play store.



- 3 Launch the App and create an account.



- 4 Tap the "add device" icon in the app to start connecting devices.



- 5 Follow the remaining steps in the app. Create areas, groups, and scenes to organize and control your devices.
- 6 You're all set!

Reset to Default Settings

If your Lightcloud Blue Edge-Lit Wafer is already paired, you can reset it by using the below methods.

Method 1: Delete from App

Open the app and access the device settings for the paired device. Be sure that the downlight is online and select "Delete".

Method 2: Manual

Power the downlight off and on 5 times consecutively. Do not allow less than 4 seconds to elapse from switch off to on, do not allow more than 2 seconds to elapse from switch on to off. The downlight will flash 3 times, then reset to 100% brightness at default CCT.



Method 3: Rapid Reset Tool

The rapid reset process must be done by professional electricians qualified by RAB. Reach out to your RAB sales manager to request a Rapid Reset Tool. The tool simply needs to be placed directly on the small Lightcloud logo on downlight for 2 seconds. The downlight will flash 3 times, then reset to 100% brightness at default CCT.



Functionality

Configuration

All configuration of Lightcloud Blue products may be performed using the Lightcloud Blue app.

Emergency default

If communication is lost, the Lightcloud Blue Edge-Lit Wafer will revert back to the last known 'On' status. This setting can be adjusted using the Lightcloud Blue mobile app.

(Warning: Any wires not in use must be capped off or otherwise insulated.)

WE'RE HERE TO HELP:

1 (844) LIGHTCLOUD

1 (844) 544-4825

support@lightcloud.com

FCC Information:

This device complies with Part 15 of the FCC Rules. Operation is subject to the following two conditions: 1. This device may not cause harmful interference, and 2. This device must accept any interference received, including interference that may cause undesired operation.

Note: This device has been tested and found to comply with the limits for Class B digital devices pursuant to Part 15 Subpart B of the FCC rules. These limits are designed to provide reasonable protection against harmful interference in a residential environment. This equipment generates, uses, and can radiate radio frequency energy, and if not installed and used in accordance with the instruction manual, may cause harmful interference to radio communications. However, there is no guarantee that interference will not occur in a particular installation. If this equipment does cause harmful interference to radio or television which can be determined by turning the equipment off and on, the user is encouraged to try and correct the interference by one or more of the following measures:

- Reorient or relocate the receiving antenna.
- Increase the separation between the equipment and receiver.
- Connect the equipment into an outlet on a circuit different from that to which the receiver is connected.
- Consult the dealer or an experienced radio/TV technician for help.

To comply with the FCC's RF exposure limits for general population / uncontrolled exposure, this transmitter must be installed provide a separation distance of at least 20 cm from all persons and must not be co-located or operating in conjunction with another antenna or transmitter.

CAUTION: Changes or modifications to this equipment not expressly approved by RAB Lighting may void the user's authority to operate this equipment.



Lightcloud®

Lightcloud Blue is a Bluetooth mesh wireless lighting control system that allows you to control RAB's various compatible devices. With RAB's patent-pending Rapid Provisioning technology, devices can be quickly and easily commissioned for residential and large commercial applications using the Lightcloud Blue mobile app. Each device in a system can communicate with any other device, eliminating the need for a Gateway or Hub and maximizing the control system's reach.

Learn more at www.rablighting.com

1(844) LIGHTCLOUD

1(844) 544-4825

RAB®

©2023 RAB LIGHTING Inc.

Made in Cambodia

Pat. rablighting.com/ip