

# INSTRUCTIONS

## FIELD-ADJUSTABLE GUS®17 INSTALLATION

# RAB®

RAB Lighting is committed to creating high-quality, affordable, well-designed and energy-efficient LED lighting and controls that make it easy for electricians to install and end users to save energy. We'd love to hear your comments. Please call the Marketing Department at 888-RAB-1000 or email: [marketing@rablighting.com](mailto:marketing@rablighting.com)

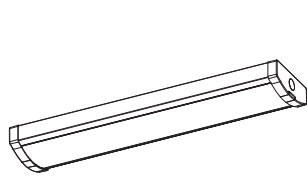

GUS17 - 2ft

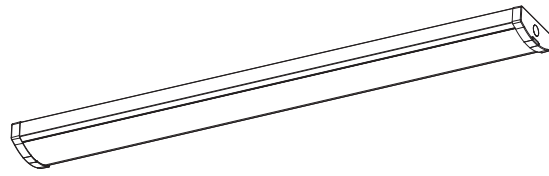

GUS17 - 4ft

### IMPORTANT

#### READ CAREFULLY BEFORE INSTALLING FIXTURE. RETAIN THESE INSTRUCTIONS FOR FUTURE REFERENCE.

RAB fixtures must be wired in accordance with the National Electrical Code and all applicable local codes. Proper grounding is required for safety. THIS PRODUCT MUST BE INSTALLED IN ACCORDANCE WITH THE APPLICABLE INSTALLATION CODE BY A PERSON FAMILIAR WITH THE CONSTRUCTION AND OPERATION OF THE PRODUCT AND THE HAZARDS INVOLVED.

**WARNING: Make certain power is OFF before installing or maintaining fixture. No user serviceable parts inside.**

**CAUTION: For proper weatherproof function all gaskets must be seated properly and all screws inserted and tightened firmly. Apply weatherproof silicone sealant around the edge of the ceiling mounting box and/or junction box. This is especially important with an uneven ceiling surface. Silicone all plugs and unused conduit entries.**

**Suitable for damp locations. Suitable for operation in ambient not exceeding 45° C.**

### SURFACE MOUNTING

The fixture is suitable for indoor applications.

1. Pry open the **Lens Clips** at each end of the **Housing** and remove the **Lens** (Fig. 1).
2. Pull supply wires from Junction Box (*not supplied*) through **Access Hole** on **Housing** as shown in Fig. 2. Secure the fixture **Housing** to the surface with appropriate fasteners for the surface.
3. Use appropriate UL rated wire connectors as required by code to make electrical splices to fixture leads. Follow appropriate mounting and wiring instructions per code.
4. Once connections are made organize all wires inside the junction box or if wires are within the fixture **Housing** arrange the wires away from the light source to prevent shadows using zip ties.
5. Replace **Lens** on fixture and secure **Lens Clips** (Fig. 3).
6. **WARNING: To prevent wiring damage or abrasion, do not expose wiring to edges of sharp objects.**

Fig: 1

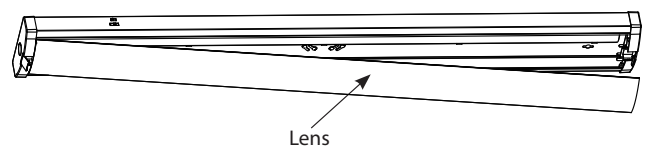
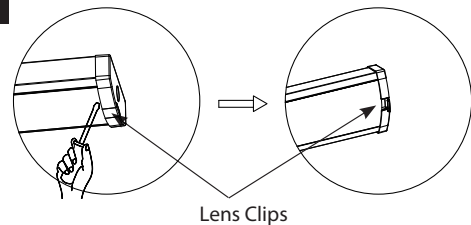

Fig: 2

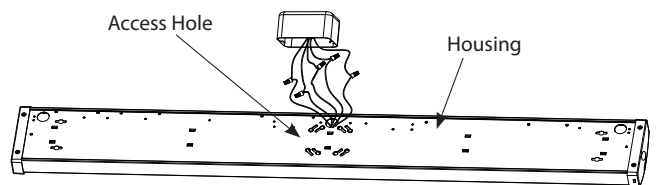
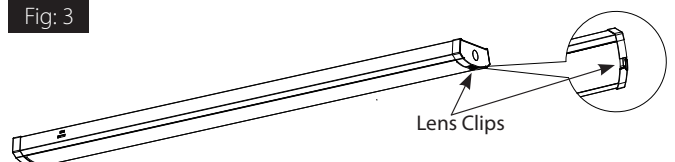

Fig: 3



# INSTRUCTIONS

## FIELD-ADJUSTABLE GUS®17 INSTALLATION

# RAB®

RAB Lighting is committed to creating high-quality, affordable, well-designed and energy-efficient LED lighting and controls that make it easy for electricians to install and end users to save energy. We'd love to hear your comments. Please call the Marketing Department at 888-RAB-1000 or email: [marketing@rablighting.com](mailto:marketing@rablighting.com)

### V-HOOK / CHAIN MOUNTING

The fixture can be mounted using V-Hooks and Chain (*ordered separately as GUS17 VHOOK KIT*).

1. Loop the **V-Hooks** into the **Mounting Slots** at each end of the **Housing** as shown in Fig 4.
2. Connect the Chains to the mounting surface and hang the fixture from V-Hooks.
3. Fixture mounting height and spacing should be determined by application requirements. **V-Hook** and **Chain** is suitable to support four (4) times the weight of the Fixture.
4. Make electrical connections as shown in wiring diagram (Fig. 8). Use approved wiring connectors and appropriate wiring method and wire to local NEC codes. Be careful not to pinch wires.
5. Once connections are made organize all wires inside the junction box or if wires are within the fixture housing arrange the wires away from the light source to prevent shadows using zip ties.
6. Replace **Lens** on fixture and secure **Lens Clips** (Fig. 3).  
**WARNING: To prevent wiring damage or abrasion, do not expose wiring to sharp objects**

### CONTINUOUS RUN MOUNTING

Multiple fixture wiring kit sold separately (*ordered separately as GUS17 JOIN KIT*).

1. Pry open the **Lens Clips** at each end of the **Housing** and remove the **Lens** (Fig. 1).
2. Install **Joiner Bracket** to connect multiple fixtures together and secure with (4) **Screws**, provided (Fig. 5).
3. Loop the **V-Hooks** into the **Mounting Slots** at each end of the **Housing** as shown in Fig. 4.
4. Connect the **Chains** to the **Mounting Surface** and hang the fixtures from the **V-Hooks** as shown in Fig. 6.
5. Fixture mounting height and spacing should be determined by application requirements. **V-Hooks** and **Chains** are suitable to support four (4) times the weight of the fixture.
6. Make electrical connections as show in wiring diagram (Fig. 8). Use approved wiring connectors and appropriate wiring method and wire to local NEC codes. Be careful not to pinch the wires.
7. Once connections are made organize all wires inside the junction box or if wires are within the fixture housing arrange the wires away from the light source to prevent shadows using zip ties.
8. Replace **Lens** on fixture and secure **Lens Clips** (Fig. 3).

**WARNING: To prevent wiring damage or abrasion, do not expose wiring to sharp objects**

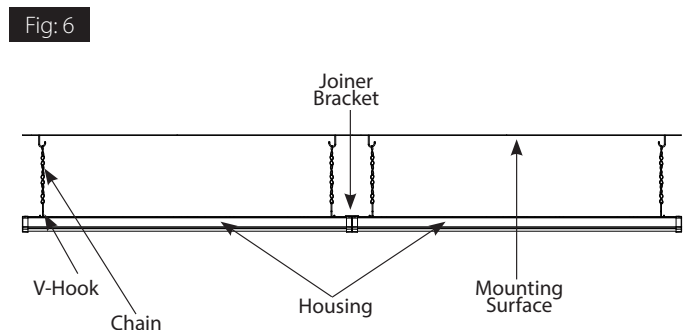
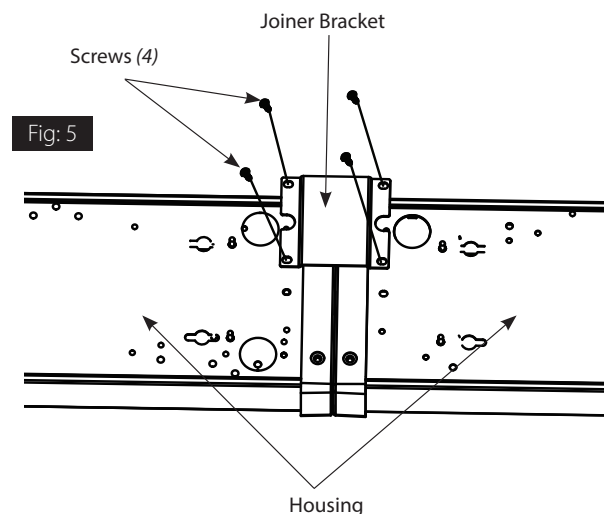
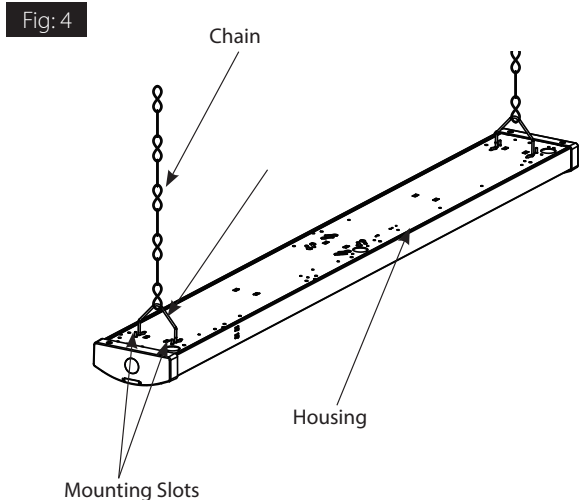

# INSTRUCTIONS

## FIELD-ADJUSTABLE GUS®17 INSTALLATION



RAB Lighting is committed to creating high-quality, affordable, well-designed and energy-efficient LED lighting and controls that make it easy for electricians to install and end users to save energy. We'd love to hear your comments. Please call the Marketing Department at 888-RAB-1000 or email: [marketing@rablighting.com](mailto:marketing@rablighting.com)

### FIELD ADJUSTMENT

Follow instructions below to change the **Fixture Power (W)** and/or **Color Temperature (CCT)** from factory settings:

#### Factory Settings:

GUS17 - 2ft 25/20/15W      25W / 4000K  
GUS17 - 4ft 50/40/30W      50W / 4000K

1. Locate the **Field Adjustable Switches** on the side of **Fixture Housing** as shown in Fig. 7.
2. Select **Power (W)** and/or **Color Temperature (CCT)** by sliding respective switch to the desired value (Fig. 7).

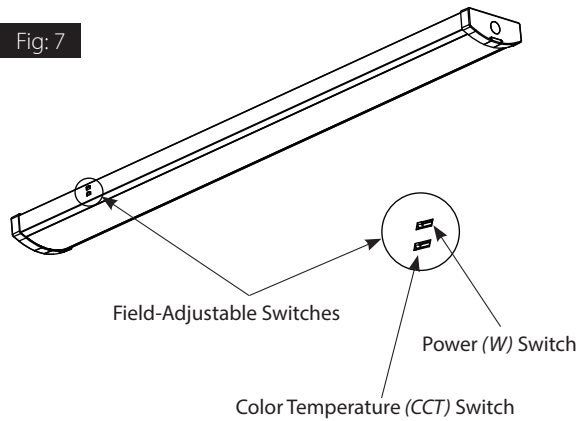

### 0-10V DIMMABLE WIRING

Universal voltage driver permits operation at 120V through 277V, 50 or 60 Hz. For 0-10V dimming follow the wiring directions as shown in Fig. 8.

1. Connect the black fixture lead to the **LINE** supply lead.
2. Connect the white fixture lead to the **COMMON** supply lead.
3. Connect the **GROUND** wire from fixture to supply ground.
4. Connect the purple fixture lead to the (V+) DIM lead.
5. Connect the pink fixture lead to the (V-) DIM lead.
6. Cap the yellow fixture lead, if present.

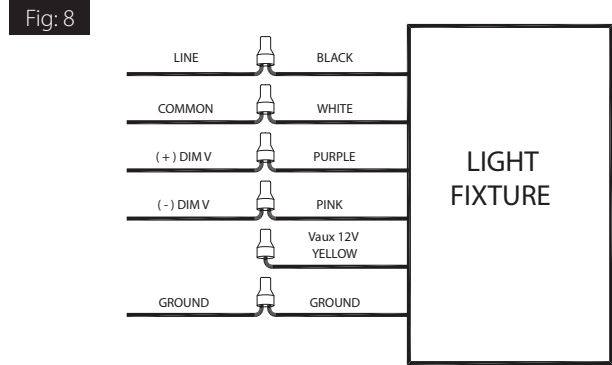

### PIR MODELS

Screw **Sensor Head** onto the **Bracket** as shown in Fig. 9. See factory settings below (optional remote sold separately for custom settings, CAT# MSR1).

#### Factory Settings:

- Brightness: 100%
- Sensitivity: 100%
- Hold Time: 1 Minute
- Stand-by dimming level: 20%
- Daylight: Disabled
- Stand-by time: 1 Minute

### MVS MODELS (Internal)

(optional remote sold separately for custom settings, CAT# MSR1).

#### Factory Settings:

- Brightness: 100%
- Sensitivity: 100%
- Hold Time: 1 Minute
- Stand-by dimming level: 20%
- Daylight: Disabled
- Stand-by time: 1 Minute

Fig: 9

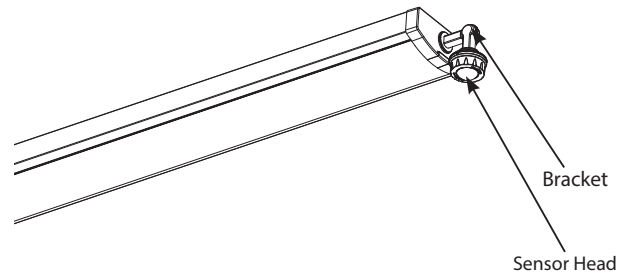

**Note:** These instructions do not cover all details or variations in equipment nor do they provide for every possible situation during installation, operation or maintenance.

# INSTRUCTIONS

## FIELD-ADJUSTABLE GUS®17 INSTALLATION



RAB Lighting is committed to creating high-quality, affordable, well-designed and energy-efficient LED lighting and controls that make it easy for electricians to install and end users to save energy. We'd love to hear your comments. Please call the Marketing Department at 888-RAB-1000 or email: [marketing@rablighting.com](mailto:marketing@rablighting.com)

# BATTERY BACKUP MODELS

## WIRING

**NOTE:** Make sure that the necessary branch circuit wiring is available. An **UNSWITCHED** AC source of power is required. The emergency driver must be fed from the same branch circuit as the LED driver.

**CAUTION:** Do not use any supply voltage other than 120-277V 50/60 HZ.

1. Connect **UNSWITCHED HOT** fixture lead to **HOT AC** supply line.
2. If using an **UNSWITCHED** circuit connect **UNSWITCHED** and **SWITCHED** lines together.
3. If using a **SWITCHED** circuit connect **SWITCHED HOT AC fixture** lead to the external.
4. For 0-10V dimming connect **DIM (+)** purple and **DIM (-)** pink leads to dimming connections.
5. All unused leads must be capped and insulated.
6. After installation is complete supply **AC power** to the fixture and then connect the **BATTERY**.
7. When power is on the fixture should be on and the **Charging Indicator Light** should illuminate to indicate the battery is charging.
8. Once the **BATTERY** has charged for at least one hour a short duration test may be performed by pressing the **Test Button** (Fig. 11).
9. After the battery has charged for 24 hours a long duration test can be performed by shutting power to the fixture.

Fig: 10

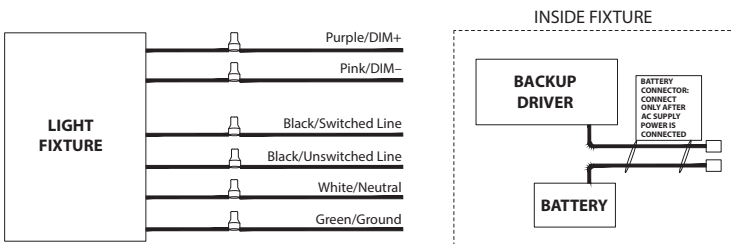

**Note:** These instructions do not cover all details or variations in equipment nor do they provide for every possible situation during installation, operation or maintenance.

## OPERATION

1. When AC power is applied the charging indicator light is illuminated indicating that the **BATTERY** is being charged.
2. When power fails the standby power automatically switches to emergency power (*internal battery*) operating at reduced illumination. The emergency driver will operate in standby power for a minimum of 90 minutes.
3. When AC power is restored the emergency driver automatically returns to charging mode.

## MAINTENANCE

Although no routine maintenance is required to keep the emergency driver functional it should be checked periodically to ensure that it is working. The following schedule is recommended:

1. Visually inspect the charging indicator light monthly. It should be illuminated.
2. Test the emergency operation of the fixture at 30-day intervals for a minimum of 30 seconds.
3. Conduct a 90-minute discharge test once a year. Fixture will operate at reduced illumination for a minimum of 90 minutes.

## TROUBLESHOOTING

1. Is the fixture grounded properly?
2. If the charging indicator light does not illuminate after pressing the **Test Button** (Fig. 11), check if battery is connected properly.

Fig: 11

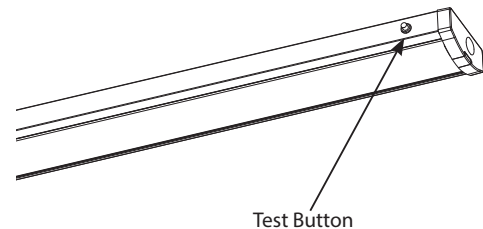

© 2023 RAB LIGHTING INC.  
GUS17-IN-0323  
P-100322

### Easy Answers

[rablighting.com](http://rablighting.com)  
Visit our website for product info

Tech Help Line  
Call our experts: 888 722-1000

e-mail  
Answered promptly - [sales@rablighting.com](mailto:sales@rablighting.com)

Free Lighting Layouts  
Answered online or by request

**RAB WARRANTY:** RAB's warranty is subject to all terms and conditions found at [rablighting.com/warranty](http://rablighting.com/warranty).