

KAI Field-Adjustable Cobra Head



KAI-70 / KAI-100



PROJECT: _____

DATE: _____

TYPE: _____

PREPARED BY: _____



KAI-150 / KAI-200



KEY FEATURES

- Available in two sizes and adjustable wattages:
Small:
KAI-70: 70/60/50W (factory default 70W) and
KAI-100: 100/80/60W (factory default 100W)
Large:
KAI-150: 150/120/100W (factory default 150W) and
KAI-200: 200/180/160W (factory default 200W)
- Adjustable CCT: **3000/4000/5000K** (factory default 4000K)
- 120-277V driver. 480V available on large models.
- Light distribution: Type II, III, & IV
- Available in **adjustable pole mount**
- House side shields, lens Kit, twistlock photocell, 20kV surge protector for 120-277V & 480V are the available accessories.
- 10-year** limited warranty

Area Light w/Selectable Wattage, CCT, and Photocell

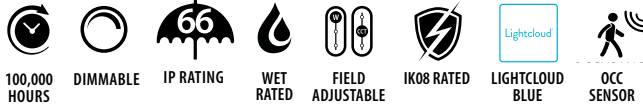

PERFORMANCE

WITHOUT SHIELD

KAI-70, TYPE II	3000K	4000K	5000K	3000K	4000K	5000K	3000K	4000K	5000K
Wattage	70W			60W			50W		
Input Watts	71.0W	67.9W	70.6W	56.9W	54.7W	56.6W	47.5W	46.0W	47.2W
Lumens	10,097	10,990	10,729	8,403	9,101	8,884	7,043	7,590	7,424
Efficacy	142.2	161.9	152	147.7	166.4	157	148.3	165	157.3
CRI	83	84	82	83	84	82	83	84	82
Voltage Ratings	120-277V			120-277V			120-277V		

KAI-70, TYPE III	3000K	4000K	5000K	3000K	4000K	5000K	3000K	4000K	5000K
Wattage	70W			60W			50W		
Input Watts	71.1W	67.9W	70.6W	56.9W	54.7W	56.5W	47.5W	45.9W	47.2W
Lumens	10,237	11,073	10,797	8,454	9,098	8,872	7,091	7,593	7,419
Efficacy	144	163.1	152.9	148.6	166.3	157	149.3	165.4	157.2
CRI	83	84	82	83	84	82	83	84	82
Voltage Ratings	120-277V			120-277V			120-277V		

KAI-70, TYPE IV	3000K	4000K	5000K	3000K	4000K	5000K	3000K	4000K	5000K
Wattage	70W			60W			50W		
Input Watts	71.0W	67.9W	70.7W	57.0W	54.8W	56.8W	47.5W	46.0W	47.3W
Lumens	10,023	10,913	10,686	8,353	9,050	8,861	7,003	7,549	7,407
Efficacy	141.2	160.7	151.1	146.5	165.1	156	147.4	164.1	156.6
CRI	83	85	82	83	85	82	83	85	82
Voltage Ratings	120-277V			120-277V			120-277V		

KAI Field-Adjustable Cobra Head



PERFORMANCE									
KAI-100, TYPE II	3000K	4000K	5000K	3000K	4000K	5000K	3000K	4000K	5000K
Wattage	100W			80W			60W		
Input Watts	98.7W	94.8W	98.4W	81.5W	78.7W	81.3W	60.9W	59.2W	60.7W
Lumens	13,682	15,106	14,730	11,719	12,874	12,554	9,123	9,972	9,743
Efficacy	138.6	159.3	149.7	143.8	163.6	154.4	149.8	168.4	160.5
CRI	83	84	82	83	84	82	83	84	82
Voltage Ratings	120-277V			120-277V			120-277V		
KAI-100, TYPE III	3000K	4000K	5000K	3000K	4000K	5000K	3000K	4000K	5000K
Wattage	100W			80W			60W		
Input Watts	99.0W	94.7W	98.5W	81.7W	78.6W	81.3W	61.0W	59.1W	60.7W
Lumens	13,875	15,179	14,938	11,876	12,927	12,722	9,228	9,994	9,856
Efficacy	140.2	160.3	151.7	145.4	164.5	156.5	151.3	169.1	162.4
CRI	83	84	82	84	84	82	83	84	82
Voltage Ratings	120-277V			120-277V			120-277V		
KAI-100, TYPE IV	3000K	4000K	5000K	3000K	4000K	5000K	3000K	4000K	5000K
Wattage	100W			80W			60W		
Input Watts	99.0W	94.5W	98.2W	81.6W	78.4W	80.9W	60.9W	58.8W	60.4W
Lumens	13,592	14,817	14,439	11,592	12,574	12,253	9,039	9,755	9,526
Efficacy	137.3	156.8	147	142.1	160.4	151.5	148.4	165.9	157.7
CRI	84	84	82	84	84	82	83	84	82
Voltage Ratings	120-277V			120-277V			120-277V		
KAI-150, TYPE II	3000K	4000K	5000K	3000K	4000K	5000K	3000K	4000K	5000K
Wattage	150W			120W			100W		
Input Watts	148.3W	141.6W	147.2W	120W	115.3W	119.1W	102.6W	99.1W	101.8W
Lumens	21,171	22,994	22,376	17,827	19,265	18,747	15,654	16,832	16,413
Efficacy	142.8	162.4	152	148.6	167.1	157.4	152.6	169.8	161.2
CRI	83	85	83	84	85	83	84	85	83
Voltage Ratings	120-277V			120-277V			120-277V		
KAI-150, TYPE III	3000K	4000K	5000K	3000K	4000K	5000K	3000K	4000K	5000K
Wattage	150W			120W			100W		
Input Watts	148.5W	141.7W	147.2W	119.9W	115.1W	118.9W	102.5W	99W	101.6W
Lumens	21,446	23,165	22,536	17,947	19,288	18,765	15,746	16,838	16,414
Efficacy	144.4	163.5	153.1	149.7	167.6	157.8	153.6	170.1	161.6
CRI	83	84	83	83	84	83	84	84	83
Voltage Ratings	120-277V			120-277V			120-277V		
KAI-150, TYPE IV	3000K	4000K	5000K	3000K	4000K	5000K	3000K	4000K	5000K
Wattage	150W			120W			100W		
Input Watts	148.1W	141.5W	147.3W	120.1W	115.4W	119.5W	102.6W	99.2W	102W
Lumens	20,967	22,861	22,284	17,747	19,253	18,768	15,579	16,816	16,425
Efficacy	141.6	161.6	151.3	147.8	166.8	157.1	151.8	169.5	161
CRI	83	84	83	84	84	83	84	84	83
Voltage Ratings	120-277V			120-277V			120-277V		

KAI Field-Adjustable Cobra Head



PERFORMANCE

KAI-150/480, TYPE II	3000K	4000K	5000K	3000K	4000K	5000K	3000K	4000K	5000K
Wattage	150W			120W			100W		
Input Watts	153.7W	144.5W	153.1W	121.1W	114.5W	120.6W	102.9W	97.9W	102.5W
Lumens	21,027	22,946	22,396	17,284	18,767	18,317	15,143	16,359	16,000
Efficacy	136.8	158.8	146.3	142.7	163.9	151.9	147.2	167.1	156.1
CRI	83	84	83	83	84	83	84	84	83
Voltage Ratings	480V			480V			480V		

KAI-150/480, TYPE III	3000K	4000K	5000K	3000K	4000K	5000K	3000K	4000K	5000K
Wattage	150W			120W			100W		
Input Watts	153.7W	144.4W	152.8W	121W	114.4W	120.3W	102.9W	97.8W	102.3W
Lumens	21,151	22,998	22,345	17,349	18,769	18,237	15,137	16,294	15,864
Efficacy	137.6	159.3	146.2	143.4	164.1	151.6	147.1	166.6	155.1
CRI	83	84	83	83	84	83	84	84	83
Voltage Ratings	480V			480V			480V		

KAI-150/480, TYPE IV	3000K	4000K	5000K	3000K	4000K	5000K	3000K	4000K	5000K
Wattage	150W			120W			100W		
Input Watts	153.6W	144.3W	152.8W	121.1W	114.5W	120.5W	102.9W	97.8W	102.4W
Lumens	20,922	22,796	22,243	17,211	18,659	18,206	14,989	16,168	15,808
Efficacy	136.2	158	145.6	142.1	163	151.1	145.7	165.3	154.4
CRI	83	85	83	83	85	83	84	85	83
Voltage Ratings	480V			480V			480V		

KAI-200, TYPE II	3000K	4000K	5000K	3000K	4000K	5000K	3000K	4000K	5000K
Wattage	200W			180W			160W		
Input Watts	198.2W	189.2W	196.8W	177.6W	170.6W	176.3W	158.4W	153W	157.3W
Lumens	27,626	30,174	29,158	25,305	27,500	26,575	23,116	24,995	24,203
Efficacy	139.4	159.5	148.2	142.5	161.2	150.7	145.9	163.4	153.9
CRI	83	85	83	83	85	83	83	85	83
Voltage Ratings	120-277V			120-277V			120-277V		

KAI-200, TYPE III	3000K	4000K	5000K	3000K	4000K	5000K	3000K	4000K	5000K
Wattage	200W			180W			160W		
Input Watts	198.7W	189.8W	197.4W	178.3W	171.3W	177.1W	158.9W	153.6W	157.9W
Lumens	28,013	30,569	29,582	25,690	27,893	26,993	23,443	25,326	24,558
Efficacy	141	161.1	149.9	144.1	162.8	152.4	147.5	164.9	155.5
CRI	83	85	83	83	85	83	83	85	83
Voltage Ratings	120-277V			120-277V			120-277V		

KAI-200, TYPE IV	3000K	4000K	5000K	3000K	4000K	5000K	3000K	4000K	5000K
Wattage	200W			180W			160W		
Input Watts	198.7W	189.6W	197.3W	178.3W	171.2W	177W	159.1W	153.6W	158W
Lumens	27,797	30,193	29,148	25,440	27,495	26,543	23,316	25,073	24,253
Efficacy	139.9	159.2	147.7	142.7	160.6	150	146.5	163.2	153.5
CRI	83	85	83	83	85	83	83	85	83
Voltage Ratings	120-277V			120-277V			120-277V		

KAI Field-Adjustable Cobra Head



PERFORMANCE

KAI-200/480, TYPE II	3000K	4000K	5000K	3000K	4000K	5000K	3000K	4000K	5000K
Wattage	200W			180W			160W		
Input Watts	204.4W	190.6W	204.2W	185.9W	174.4W	185.7W	164.9W	155.6W	164.7W
Lumens	27,334	30,006	28,869	25,295	27,629	26,582	23,150	25,159	24,255
Efficacy	133.7	157.4	141.4	136.1	158.4	143.1	140.4	161.7	147.3
CRI	83	85	83	83	85	83	84	85	83
Voltage Ratings	480V			480V			480V		

KAI-200/480, TYPE III	3000K	4000K	5000K	3000K	4000K	5000K	3000K	4000K	5000K
Wattage	200W			180W			160W		
Input Watts	204.1W	190.3W	204.1W	185.8W	174.3W	185.8W	164.8W	155.5W	164.8W
Lumens	26,972	29,927	28,810	25,279	27,909	26,866	23,142	25,421	24,521
Efficacy	132.2	157.3	141.2	136.1	160.1	144.6	140.4	163.5	148.8
CRI	83	85	83	83	85	83	84	85	83
Voltage Ratings	480V			480V			480V		

KAI-200/480, TYPE IV	3000K	4000K	5000K	3000K	4000K	5000K	3000K	4000K	5000K
Wattage	200W			180W			160W		
Input Watts	204.3W	190.6W	204.1W	185.7W	174.3W	185.5W	164.8W	155.6W	164.6W
Lumens	27,094	29,839	28,512	24,982	27,375	26,158	22,851	24,914	23,855
Efficacy	132.6	156.6	139.7	134.5	157.1	141	138.7	160.1	144.9
CRI	83	85	83	83	85	83	83	85	83
Voltage Ratings	480V			480V			480V		

WITH 4-SIDED SHIELD

KAI-70, TYPE II	3000K	4000K	5000K	3000K	4000K	5000K	3000K	4000K	5000K
Wattage	70W			60W			50W		
Input Watts	71.1W	67.9W	70.5W	56.8W	54.2W	56.3W	47.4W	45.3W	47W
Lumens	7,409	8,077	7,905	6,143	6,697	6,554	5,152	5,617	5,497
Efficacy	104.2	119	112.1	108.2	123.6	116.4	108.7	124	117
CRI	83	84	82	83	84	82	83	84	82
Voltage Ratings	120-277V			120-277V			120-277V		

KAI-70, TYPE III	3000K	4000K	5000K	3000K	4000K	5000K	3000K	4000K	5000K
Wattage	70W			60W			50W		
Input Watts	71.1W	67.9W	70.5W	56.8W	54.2W	56.3W	47.4W	45.3W	47W
Lumens	7,296	7,960	7,785	6,048	6,599	6,454	5,076	5,538	5,416
Efficacy	102.6	117.2	110.4	106.5	121.8	114.6	107.1	122.3	115.2
CRI	83	84	82	83	84	82	83	84	82
Voltage Ratings	120-277V			120-277V			120-277V		

KAI-70, TYPE IV	3000K	4000K	5000K	3000K	4000K	5000K	3000K	4000K	5000K
Wattage	70W			60W			50W		
Input Watts	71.1W	67.9W	70.6W	56.9W	54.3W	56.5W	47.5W	45.4W	47.2W
Lumens	6,873	7,499	7,345	5,703	6,223	6,094	4,780	5,216	5,108
Efficacy	96.7	110.4	104	100.2	114.6	107.9	100.6	114.9	108.2
CRI	83	85	82	83	85	82	83	85	82
Voltage Ratings	120-277V			120-277V			120-277V		

KAI Field-Adjustable Cobra Head



PERFORMANCE									
KAI-100, TYPE II	3000K	4000K	5000K	3000K	4000K	5000K	3000K	4000K	5000K
Wattage	100W			80W			60W		
Input Watts	98.8W	94.3W	97.9W	81.3W	77.6W	80.6W	60.7W	57.9W	60.1W
Lumens	9,806	10,725	10,473	8,369	9,153	8,938	6,529	7,141	6,973
Efficacy	99.3	113.7	107	102.9	118	110.9	107.6	123.3	116
CRI	83	84	82	83	84	82	83	84	82
Voltage Ratings	120-277V			120-277V			120-277V		
KAI-100, TYPE III	3000K	4000K	5000K	3000K	4000K	5000K	3000K	4000K	5000K
Wattage	100W			80W			60W		
Input Watts	98.9W	94.5W	98.1W	81.5W	77.9W	80.8W	60.9W	58.2W	60.4W
Lumens	9,704	10,605	10,354	8,276	9,045	8,830	6,454	7,053	6,886
Efficacy	98.1	112.2	105.5	101.5	116.1	109.3	106	121.2	114
CRI	83	84	82	84	84	82	83	84	82
Voltage Ratings	120-277V			120-277V			120-277V		
KAI-100, TYPE IV	3000K	4000K	5000K	3000K	4000K	5000K	3000K	4000K	5000K
Wattage	100W			80W			60W		
Input Watts	98.8W	94.4W	98W	81.4W	77.8W	80.7W	60.8W	58.1W	60.3W
Lumens	9,099	9,942	9,714	7,741	8,458	8,264	6,041	6,601	6,449
Efficacy	92.1	105.3	99.1	95.1	108.7	102.4	99.4	113.6	106.9
CRI	84	84	82	84	84	82	83	84	82
Voltage Ratings	120-277V			120-277V			120-277V		
KAI-150, TYPE II	3000K	4000K	5000K	3000K	4000K	5000K	3000K	4000K	5000K
Wattage	150W			120W			100W		
Input Watts	148W	141.3W	147W	119.7W	114.3W	118.9W	102.3W	97.7W	101.6W
Lumens	17,241	18,784	18,290	14,497	15,795	15,379	12,730	13,869	13,504
Efficacy	116.5	132.9	124.4	121.1	138.2	129.3	124.4	142	132.9
CRI	83	85	83	84	85	83	84	85	83
Voltage Ratings	120-277V			120-277V			120-277V		
KAI-150, TYPE III	3000K	4000K	5000K	3000K	4000K	5000K	3000K	4000K	5000K
Wattage	150W			120W			100W		
Input Watts	147.6W	141W	146.6W	119.4W	114.1W	118.6W	102W	97.4W	101.3W
Lumens	16,963	18,599	18,115	14,373	15,759	15,349	12,619	13,836	13,476
Efficacy	114.9	131.9	123.6	120.4	138.1	129.4	123.7	142.1	133
CRI	83	84	83	83	84	83	84	84	83
Voltage Ratings	120-277V			120-277V			120-277V		
KAI-150, TYPE IV	3000K	4000K	5000K	3000K	4000K	5000K	3000K	4000K	5000K
Wattage	150W			120W			100W		
Input Watts	147.6W	141.2W	146.8W	119.5W	114.3W	118.9W	102.1W	97.7W	101.5W
Lumens	16,285	17,845	17,413	13,773	15,092	14,727	12,073	13,229	12,909
Efficacy	110.3	126.4	118.6	115.3	132	123.9	118.2	135.4	127.2
CRI	83	84	83	84	84	83	84	84	83
Voltage Ratings	120-277V			120-277V			120-277V		

KAI Field-Adjustable Cobra Head



PERFORMANCE

KAI-150/480, TYPE II	3000K	4000K	5000K	3000K	4000K	5000K	3000K	4000K	5000K
Wattage	150W			120W			100W		
Input Watts	153.6W	144.3W	152.7W	121W	113.7W	120.3W	102.9W	96.7W	102.3W
Lumens	17,354	18,938	18,428	14,271	15,574	15,154	12,434	13,569	13,204
Efficacy	113	131.2	120.7	117.9	137	126	120.8	140.3	129.1
CRI	83	84	83	83	84	83	84	84	83
Voltage Ratings	480V			480V			480V		

KAI-150/480, TYPE III	3000K	4000K	5000K	3000K	4000K	5000K	3000K	4000K	5000K
Wattage	150W			120W			100W		
Input Watts	153.3W	144.1W	152.5W	120.9W	113.6W	120.3W	102.8W	96.6W	102.3W
Lumens	17,045	18,681	18,167	14,058	15,407	14,984	12,275	13,453	13,083
Efficacy	111.2	129.6	119.1	116.3	135.6	124.6	119.4	139.3	127.9
CRI	83	84	83	83	84	83	84	84	83
Voltage Ratings	480V			480V			480V		

KAI-150/480, TYPE IV	3000K	4000K	5000K	3000K	4000K	5000K	3000K	4000K	5000K
Wattage	150W			120W			100W		
Input Watts	153.3W	144W	152.5W	120.9W	113.6W	120.3W	102.8W	96.6W	102.3W
Lumens	16,132	17,761	17,278	13,365	14,715	14,314	11,667	12,845	12,496
Efficacy	105.2	123.3	113.3	110.5	129.5	119.0	113.5	133.0	122.2
CRI	83	85	83	83	85	83	84	85	83
Voltage Ratings	480V			480V			480V		

KAI-200, TYPE II	3000K	4000K	5000K	3000K	4000K	5000K	3000K	4000K	5000K
Wattage	200W			180W			160W		
Input Watts	197.5W	188.6W	196.3W	177.1W	169.1W	176W	158.1W	151W	157.1W
Lumens	21,948	24,152	23,356	20,170	22,195	21,464	18,465	20,319	19,649
Efficacy	111.1	128.1	119	113.9	131.3	122	116.8	134.6	125.1
CRI	83	85	83	83	85	83	83	85	83
Voltage Ratings	120-277V			120-277V			120-277V		

KAI-200, TYPE III	3000K	4000K	5000K	3000K	4000K	5000K	3000K	4000K	5000K
Wattage	200W			180W			160W		
Input Watts	197.2W	188.3W	195.9W	176.7W	168.7W	175.5W	157.6W	150.5W	156.6W
Lumens	21,967	24,181	23,369	20,142	22,172	21,428	18,414	20,270	19,590
Efficacy	111.4	128.4	119.3	114	131.4	122.1	116.8	134.7	125.1
CRI	83	85	83	83	85	83	83	85	83
Voltage Ratings	120-277V			120-277V			120-277V		

KAI-200, TYPE IV	3000K	4000K	5000K	3000K	4000K	5000K	3000K	4000K	5000K
Wattage	200W			180W			160W		
Input Watts	197.3W	188.5W	196.1W	176.9W	169W	175.8W	157.8W	150.8W	156.8W
Lumens	20,718	22,862	22,133	19,026	20,995	20,325	17,397	19,197	18,585
Efficacy	105	121.3	112.9	107.6	124.2	115.6	110.2	127.3	118.5
CRI	83	85	83	83	85	83	83	85	83
Voltage Ratings	120-277V			120-277V			120-277V		

KAI Field-Adjustable Cobra Head



PERFORMANCE

KAI-200/480, TYPE II	3000K	4000K	5000K	3000K	4000K	5000K	3000K	4000K	5000K
Wattage	200W			180W			160W		
Input Watts	204W	190.2W	203.9W	185.7W	173.1W	185.6W	164.7W	153.6W	164.6W
Lumens	21,571	23,921	22,976	20,162	22,359	21,475	18,459	20,470	19,661
Efficacy	105.7	125.8	112.7	108.6	129.2	115.7	112.1	133.3	119.4
CRI	83	85	83	83	85	83	84	85	83
Voltage Ratings	480V			480V			480V		

KAI-200/480, TYPE III	3000K	4000K	5000K	3000K	4000K	5000K	3000K	4000K	5000K
Wattage	200W			180W			160W		
Input Watts	204W	190W	203.9W	185.7W	173W	185.6W	164.7W	153.4W	164.6W
Lumens	21,277	23,626	22,756	19,955	22,158	21,342	18,285	20,304	19,556
Efficacy	104.3	124.3	111.6	107.5	128.1	115.0	111.0	132.4	118.8
CRI	83	85	83	83	85	83	84	85	83
Voltage Ratings	480V			480V			480V		

KAI-200/480, TYPE IV	3000K	4000K	5000K	3000K	4000K	5000K	3000K	4000K	5000K
Wattage	200W			180W			160W		
Input Watts	204.6W	190.4W	204.3W	186.7W	173.7W	186.4W	166.6W	155W	166.4W
Lumens	20,235	22,499	21,677	18,899	21,013	20,246	17,293	19,227	18,525
Efficacy	98.9	118.2	106.1	101.2	121.0	108.6	103.8	124.0	111.3
CRI	83	85	83	83	85	83	83	85	83
Voltage Ratings	480V			480V			480V		

WITH FRONT SIDE SHIELD

KAI-70, TYPE II	3000K	4000K	5000K	3000K	4000K	5000K	3000K	4000K	5000K
Wattage	70W			60W			50W		
Input Watts	71W	67.8W	70.5W	56.8W	54.2W	56.4W	47.4W	45.3W	47.1W
Lumens	7,035	7,759	7,663	5,828	6,428	6,348	4,887	5,390	5,323
Efficacy	99.1	114.4	108.7	102.6	118.6	112.6	103.1	119	113
CRI	83	84	82	83	84	82	83	84	82
Voltage Ratings	120-277V			120-277V			120-277V		

KAI-70, TYPE III	3000K	4000K	5000K	3000K	4000K	5000K	3000K	4000K	5000K
Wattage	70W			60W			50W		
Input Watts	71.1W	67.9W	70.6W	56.9W	54.3W	56.5W	47.5W	45.4W	47.2W
Lumens	6,839	7,540	7,449	5,676	6,258	6,182	4,762	5,250	5,187
Efficacy	96.2	111	105.5	99.8	115.2	109.4	100.3	115.6	109.9
CRI	83	84	82	83	84	82	83	84	82
Voltage Ratings	120-277V			120-277V			120-277V		

KAI-70, TYPE IV	3000K	4000K	5000K	3000K	4000K	5000K	3000K	4000K	5000K
Wattage	70W			60W			50W		
Input Watts	71.1W	67.9W	70.5W	56.8W	54.2W	56.3W	47.4W	45.3W	47W
Lumens	6,447	7,111	7,028	5,353	5,904	5,835	4,488	4,950	4,892
Efficacy	90.7	104.7	99.7	94.2	108.9	103.6	94.7	109.3	104.1
CRI	83	85	82	83	85	82	83	85	82
Voltage Ratings	120-277V			120-277V			120-277V		

KAI Field-Adjustable Cobra Head



PERFORMANCE									
KAI-100, TYPE II	3000K	4000K	5000K	3000K	4000K	5000K	3000K	4000K	5000K
Wattage	100W			80W			60W		
Input Watts	98.6W	94.2W	97.9W	81.2W	77.6W	80.6W	60.7W	58W	60.3W
Lumens	9,322	10,291	10,138	7,938	8,763	8,632	6,191	6,834	6,733
Efficacy	94.5	109.2	103.6	97.8	112.9	107.1	102	117.8	111.7
CRI	83	84	82	83	84	82	83	84	82
Voltage Ratings	120-277V			120-277V			120-277V		
KAI-100, TYPE III	3000K	4000K	5000K	3000K	4000K	5000K	3000K	4000K	5000K
Wattage	100W			80W			60W		
Input Watts	98.9W	94.5W	98.1W	81.6W	78W	80.9W	60.9W	58.2W	60.4W
Lumens	9,098	10,044	9,906	7,768	8,576	8,458	6,045	6,674	6,582
Efficacy	92	106.3	101	95.2	109.9	104.5	99.3	114.7	109
CRI	83	84	82	84	84	82	83	84	82
Voltage Ratings	120-277V			120-277V			120-277V		
KAI-100, TYPE IV	3000K	4000K	5000K	3000K	4000K	5000K	3000K	4000K	5000K
Wattage	100W			80W			60W		
Input Watts	98.8W	94.3W	98W	81.4W	77.7W	80.7W	60.8W	58W	60.3W
Lumens	8,521	9,418	9,284	7,279	8,046	7,931	5,688	6,287	6,198
Efficacy	86.2	99.9	94.7	89.4	103.6	98.3	93.6	108.4	102.8
CRI	84	84	82	84	84	82	83	84	82
Voltage Ratings	120-277V			120-277V			120-277V		
KAI-150, TYPE II	3000K	4000K	5000K	3000K	4000K	5000K	3000K	4000K	5000K
Wattage	150W			120W			100W		
Input Watts	147.9W	141.3W	147W	119.7W	114.4W	119W	102.4W	97.8W	101.8W
Lumens	16,489	18,144	17,799	13,924	15,322	15,030	12,240	13,469	13,212
Efficacy	111.5	128.4	121.1	116.3	133.9	126.3	119.5	137.7	129.8
CRI	83	85	83	84	85	83	84	85	83
Voltage Ratings	120-277V			120-277V			120-277V		
KAI-150, TYPE III	3000K	4000K	5000K	3000K	4000K	5000K	3000K	4000K	5000K
Wattage	150W			120W			100W		
Input Watts	148.2W	141.2W	147.1W	120W	114.3W	119.1W	102.7W	97.8W	101.9W
Lumens	16,253	17,879	17,517	13,727	15,101	14,795	12,055	13,261	12,993
Efficacy	109.7	126.6	119.1	114.4	132.1	124.2	117.4	135.6	127.5
CRI	83	84	83	83	84	83	84	84	83
Voltage Ratings	120-277V			120-277V			120-277V		
KAI-150, TYPE IV	3000K	4000K	5000K	3000K	4000K	5000K	3000K	4000K	5000K
Wattage	150W			120W			100W		
Input Watts	147.8W	141.2W	146.8W	119.5W	114.2W	118.7W	102.2W	97.6W	101.5W
Lumens	15,291	16,796	16,444	12,892	14,161	13,864	11,321	12,435	12,175
Efficacy	103.5	119	112	107.9	124	116.8	110.8	127.4	120
CRI	83	84	83	84	84	83	84	84	83
Voltage Ratings	120-277V			120-277V			120-277V		

KAI Field-Adjustable Cobra Head



PERFORMANCE

KAI-150/480, TYPE II	3000K	4000K	5000K	3000K	4000K	5000K	3000K	4000K	5000K
Wattage	150W			120W			100W		
Input Watts	153.3W	144.1W	152.7W	121W	113.7W	120.5W	102.8W	96.6W	102.4W
Lumens	16,448	18,202	17,826	13,635	15,089	14,778	11,879	13,146	12,875
Efficacy	107.3	126.3	116.7	112.7	132.7	122.6	115.6	136.1	125.7
CRI	83	84	83	83	84	83	84	84	83
Voltage Ratings	480V			480V			480V		

KAI-150/480, TYPE III	3000K	4000K	5000K	3000K	4000K	5000K	3000K	4000K	5000K
Wattage	150W			120W			100W		
Input Watts	153.4W	144.1W	152.7W	120.9W	113.6W	120.3W	102.7W	96.5W	102.2W
Lumens	16,039	17,736	17,352	13,269	14,673	14,355	11,568	12,792	12,515
Efficacy	104.6	123.1	113.6	109.8	129.2	119.3	112.6	132.6	122.5
CRI	83	84	83	83	84	83	84	84	83
Voltage Ratings	480V			480V			480V		

KAI-150/480, TYPE IV	3000K	4000K	5000K	3000K	4000K	5000K	3000K	4000K	5000K
Wattage	150W			120W			100W		
Input Watts	153.6W	144.3W	152.9W	121.1W	113.8W	120.5W	102.7W	96.5W	102.2W
Lumens	15,262	16,778	16,401	12,549	13,795	13,486	10,908	11,991	11,722
Efficacy	99.4	116.3	107.3	103.6	121.2	111.9	106.2	124.3	114.7
CRI	83	85	83	83	85	83	84	85	83
Voltage Ratings	480V			480V			480V		

KAI-200, TYPE II	3000K	4000K	5000K	3000K	4000K	5000K	3000K	4000K	5000K
Wattage	200W			180W			160W		
Input Watts	197.6W	188.7W	196.3W	177.1W	169.1W	175.9W	158W	150.9W	157W
Lumens	21,242	23,463	22,797	19,476	21,512	20,901	17,802	19,663	19,105
Efficacy	107.5	124.3	116.1	110	127.2	118.8	112.7	130.3	121.7
CRI	83	85	83	83	85	83	83	85	83
Voltage Ratings	120-277V			120-277V			120-277V		

KAI-200, TYPE III	3000K	4000K	5000K	3000K	4000K	5000K	3000K	4000K	5000K
Wattage	200W			180W			160W		
Input Watts	197.5W	188.2W	195.8W	176.6W	168.3W	175.1W	157.6W	150.2W	156.2W
Lumens	21,046	23,202	22,519	19,238	21,209	20,584	17,603	19,407	18,835
Efficacy	106.6	123.3	115	108.9	126	117.6	111.7	129.2	120.6
CRI	83	85	83	83	85	83	83	85	83
Voltage Ratings	120-277V			120-277V			120-277V		

KAI-200, TYPE IV	3000K	4000K	5000K	3000K	4000K	5000K	3000K	4000K	5000K
Wattage	200W			180W			160W		
Input Watts	196.8W	188.3W	196.1W	176.9W	169.3W	176.3W	157.9W	151.1W	157.3W
Lumens	19,562	21,803	21,223	18,078	20,149	19,613	16,549	18,445	17,954
Efficacy	99.4	115.8	108.2	102.2	119	111.2	104.8	122.1	114.1
CRI	83	85	83	83	85	83	83	85	83
Voltage Ratings	120-277V			120-277V			120-277V		

KAI Field-Adjustable Cobra Head



PERFORMANCE

KAI-200/480, TYPE II	3000K	4000K	5000K	3000K	4000K	5000K	3000K	4000K	5000K
Wattage	200W			180W			160W		
Input Watts	204.1W	190.2W	203.9W	185.6W	173W	185.4W	164.7W	153.5W	164.5W
Lumens	20,972	23,354	22,460	19,512	21,729	20,896	17,858	19,887	19,125
Efficacy	102.8	122.8	110.2	105.1	125.6	112.7	108.4	129.6	116.3
CRI	83	85	83	83	85	83	84	85	83
Voltage Ratings	480V			480V			480V		

KAI-200/480, TYPE III	3000K	4000K	5000K	3000K	4000K	5000K	3000K	4000K	5000K
Wattage	200W			180W			160W		
Input Watts	204.2W	190.3W	203.9W	185.7W	173.1W	185.4W	164.7W	153.5W	164.5W
Lumens	20,545	22,868	21,991	19,020	21,171	20,359	17,398	19,365	18,623
Efficacy	100.6	120.2	107.9	102.4	122.3	109.8	105.6	126.2	113.2
CRI	83	85	83	83	85	83	84	85	83
Voltage Ratings	480V			480V			480V		

KAI-200/480, TYPE IV	3000K	4000K	5000K	3000K	4000K	5000K	3000K	4000K	5000K
Wattage	200W			180W			160W		
Input Watts	204.2W	190.4W	203.9W	186.3W	173.7W	186W	165.9W	154.7W	165.7W
Lumens	19,220	21,737	20,891	17,891	20,234	19,447	16,377	18,521	17,801
Efficacy	94.1	114.2	102.5	96	116.5	104.6	98.7	119.7	107.4
CRI	83	85	83	83	85	83	83	85	83
Voltage Ratings	480V			480V			480V		

WITH HOUSE SIDE SHIELD

KAI-70, TYPE II	3000K	4000K	5000K	3000K	4000K	5000K	3000K	4000K	5000K
Wattage	70W			60W			50W		
Input Watts	71.0W	67.8W	70.5W	56.8W	54.2W	56.4W	47.4W	45.3W	47.1W
Lumens	8,023	8,631	8,331	6,673	7,107	6,860	5,596	5,960	5,752
Efficacy	113	127	118	118	131	122	118	132	122
CRI	83	84	82	83	84	82	83	84	82
Voltage Ratings	120-277V			120-277V			120-277V		

KAI-70, TYPE III	3000K	4000K	5000K	3000K	4000K	5000K	3000K	4000K	5000K
Wattage	70W			60W			50W		
Input Watts	71.0W	67.8W	70.6W	56.9W	54.3W	56.6W	47.5W	45.4W	47.2W
Lumens	8,167	8,778	8,474	6,801	7,237	6,986	5,707	6,073	5,862
Efficacy	115	130	120	120	133	123	120	134	124
CRI	83	84	82	83	84	82	83	84	82
Voltage Ratings	120-277V			120-277V			120-277V		

KAI-70, TYPE IV	3000K	4000K	5000K	3000K	4000K	5000K	3000K	4000K	5000K
Wattage	70W			60W			50W		
Input Watts	71.1W	68.0W	70.6W	56.9W	54.4W	56.5W	47.5W	45.4W	47.2W
Lumens	8,124	8,728	8,423	6,738	7,167	6,916	5,646	6,005	5,795
Efficacy	114	128	119	118	132	122	119	132	123
CRI	83	85	82	83	85	82	83	85	82
Voltage Ratings	120-277V			120-277V			120-277V		

KAI Field-Adjustable Cobra Head



PERFORMANCE									
KAI-100, TYPE II	3000K	4000K	5000K	3000K	4000K	5000K	3000K	4000K	5000K
Wattage	100W			80W			60W		
Input Watts	98.7W	94.3W	97.9W	81.3W	77.7W	80.6W	60.7W	58.0W	60.2W
Lumens	10,904	11,741	11,310	9,286	9,899	9,535	7,239	7,717	7,433
Efficacy	111	125	116	114	127	118	119	133	124
CRI	83	84	82	83	84	82	83	84	82
Voltage Ratings	120-277V			120-277V			120-277V		
KAI-100, TYPE III	3000K	4000K	5000K	3000K	4000K	5000K	3000K	4000K	5000K
Wattage	100W			80W			60W		
Input Watts	98.9W	94.5W	98.2W	81.7W	78.1W	81.1W	61.0W	58.3W	60.6W
Lumens	11,213	12,084	11,663	9,598	10,240	9,883	7,506	8,008	7,729
Efficacy	113	128	119	118	131	122	123	137	128
CRI	83	84	82	84	84	82	83	84	82
Voltage Ratings	120-277V			120-277V			120-277V		
KAI-100, TYPE IV	3000K	4000K	5000K	3000K	4000K	5000K	3000K	4000K	5000K
Wattage	100W			80W			60W		
Input Watts	98.0W	93.7W	97.4W	81.5W	77.9W	81.0W	60.9W	58.2W	60.5W
Lumens	10,959	11,818	11,412	9,402	10,038	9,693	7,335	7,831	7,562
Efficacy	112	126	117	115	129	120	120	135	125
CRI	84	84	82	84	84	82	83	84	82
Voltage Ratings	120-277V			120-277V			120-277V		
KAI-150, TYPE II	3000K	4000K	5000K	3000K	4000K	5000K	3000K	4000K	5000K
Wattage	150W			120W			100W		
Input Watts	147.7W	141.2W	146.8W	119.6W	114.3W	118.9W	102.2W	97.7W	101.6W
Lumens	18,081	19,587	18,961	15,290	16,398	15,874	13,420	14,392	13,933
Efficacy	122	139	129	128	144	134	131	147	137
CRI	83	85	83	84	85	83	84	85	83
Voltage Ratings	120-277V			120-277V			120-277V		
KAI-150, TYPE III	3000K	4000K	5000K	3000K	4000K	5000K	3000K	4000K	5000K
Wattage	150W			120W			100W		
Input Watts	147.9W	141.2W	146.8W	119.8W	114.4W	118.9W	102.2W	97.6W	101.4W
Lumens	18,371	19,878	19,228	15,555	16,663	16,118	13,613	14,583	14,106
Efficacy	124	141	131	130	146	136	133	149	139
CRI	83	84	83	83	84	83	84	84	83
Voltage Ratings	120-277V			120-277V			120-277V		
KAI-150, TYPE IV	3000K	4000K	5000K	3000K	4000K	5000K	3000K	4000K	5000K
Wattage	150W			120W			100W		
Input Watts	147.8W	141.0W	146.7W	119.5W	114.0W	118.6W	102.3W	97.6W	101.5W
Lumens	18,163	19,670	19,043	15,330	16,436	15,912	13,493	14,466	14,005
Efficacy	123	140	130	128	144	134	132	148	138
CRI	83	84	83	84	84	83	84	84	83
Voltage Ratings	120-277V			120-277V			120-277V		

KAI Field-Adjustable Cobra Head



PERFORMANCE

KAI-150/480, TYPE II	3000K	4000K	5000K	3000K	4000K	5000K	3000K	4000K	5000K
Wattage	150W			120W			100W		
Input Watts	153.5W	144.2W	152.6W	121.0W	113.7W	120.3W	102.8W	96.6W	102.2W
Lumens	18,023	19,595	18,939	14,906	16,044	15,507	12,993	13,985	13,517
Efficacy	117	136	124	123	141	129	126	145	132
CRI	83	84	83	83	84	83	84	84	83
Voltage Ratings	480V			480V			480V		

KAI-150/480, TYPE III	3000K	4000K	5000K	3000K	4000K	5000K	3000K	4000K	5000K
Wattage	150W			120W			100W		
Input Watts	153.7W	144.4W	152.8W	121.0W	113.7W	120.3W	102.8W	96.6W	102.2W
Lumens	18,492	19,963	19,273	15,144	16,185	15,626	13,188	14,094	13,608
Efficacy	120	138	126	125	142	130	128	146	133
CRI	83	84	83	83	84	83	84	84	83
Voltage Ratings	480V			480V			480V		

KAI-150/480, TYPE IV	3000K	4000K	5000K	3000K	4000K	5000K	3000K	4000K	5000K
Wattage	150W			120W			100W		
Input Watts	153.5W	144.3W	152.7W	121.0W	113.7W	120.4W	102.8W	96.6W	102.3W
Lumens	18,206	19,759	19,105	15,002	16,119	15,586	13,063	14,036	13,571
Efficacy	119	137	125	124	142	130	127	145	133
CRI	83	85	83	83	85	83	84	85	83
Voltage Ratings	480V			480V			480V		

KAI-200, TYPE II	3000K	4000K	5000K	3000K	4000K	5000K	3000K	4000K	5000K
Wattage	200W			180W			160W		
Input Watts	197.9W	188.9W	196.5W	177.3W	169.2W	176.0W	158.2W	151.0W	157.1W
Lumens	23,526	25,571	24,534	21,579	23,220	22,279	19,725	21,225	20,365
Efficacy	119	135	125	122	137	127	125	141	130
CRI	83	85	83	83	85	83	83	85	83
Voltage Ratings	120-277V			120-277V			120-277V		

KAI-200, TYPE III	3000K	4000K	5000K	3000K	4000K	5000K	3000K	4000K	5000K
Wattage	200W			180W			160W		
Input Watts	198.2W	189.3W	196.9W	177.7W	169.7W	176.5W	158.5W	151.4W	157.5W
Lumens	24,158	26,260	25,205	22,165	23,853	22,894	20,256	21,798	20,922
Efficacy	122	139	128	125	141	130	128	144	133
CRI	83	85	83	83	85	83	83	85	83
Voltage Ratings	120-277V			120-277V			120-277V		

KAI-200, TYPE IV	3000K	4000K	5000K	3000K	4000K	5000K	3000K	4000K	5000K
Wattage	200W			180W			160W		
Input Watts	198.3W	188.9W	196.4W	177.8W	169.4W	176.1W	158.1W	150.6W	156.6W
Lumens	23,683	25,599	24,517	21,711	23,233	22,251	19,723	21,106	20,214
Efficacy	119	136	125	122	137	126	125	140	129
CRI	83	85	83	83	85	83	83	85	83
Voltage Ratings	120-277V			120-277V			120-277V		

KAI Field-Adjustable Cobra Head



PERFORMANCE

KAI-200/480, TYPE II	3000K	4000K	5000K	3000K	4000K	5000K	3000K	4000K	5000K
Wattage	200W			180W			160W		
Input Watts	204.1W	190.3W	204.0W	185.8W	173.2W	185.7W	164.8W	153.7W	164.7W
Lumens	22,975	25,243	24,049	21,475	23,359	22,254	19,637	21,360	20,350
Efficacy	113	133	118	116	135	120	119	139	124
CRI	83	85	83	83	85	83	84	85	83
Voltage Ratings	480V			480V			480V		

KAI-200/480, TYPE III	3000K	4000K	5000K	3000K	4000K	5000K	3000K	4000K	5000K
Wattage	200W			180W			160W		
Input Watts	204.2W	190.3W	204.0W	185.8W	173.2W	185.6W	164.9W	153.7W	164.7W
Lumens	23,441	25,546	24,392	21,779	23,498	22,436	19,937	21,510	20,538
Efficacy	115	134	120	117	136	121	121	140	125
CRI	83	85	83	83	85	83	84	85	83
Voltage Ratings	480V			480V			480V		

KAI-200/480, TYPE IV	3000K	4000K	5000K	3000K	4000K	5000K	3000K	4000K	5000K
Wattage	200W			180W			160W		
Input Watts	204.7W	191.0W	204.6W	186.5W	174.0W	186.4W	165.6W	154.5W	165.5W
Lumens	22,982	25,230	24,051	21,455	23,318	22,228	19,648	21,354	20,356
Efficacy	112	132	118	115	134	119	119	138.2	123
CRI	83	85	83	83	85	83	83	85	83
Voltage Ratings	480V			480V			480V		

TECHNICAL SPECIFICATIONS

COMPLIANCE

UL Listed

Suitable for wet locations

IP Rating

Ingress protection rating of IP66 for dust and water

IK Rating

IK08 rated for protection against impact

Trade Agreement Act Compliant

This product is a product of Cambodia and a "designated country" end product that complies with the Trade Agreements Act

DLC Listing

This product family is listed with the DesignLights Consortium (DLC). Individual SKUs within this family may carry either a DLC Standard or DLC Premium qualification. Please refer to the individual product specification sheet or the DLC Qualified Products List (QPL) at designlights.org to confirm the qualification status of a specific SKU prior to specification or purchase.

Model#	DLC ID	Model#	DLC ID
KAI-2T70	S-J45HB3	KAI-3T70	S-CK6424
KAI-2T100	S-F7TP3X	KAI-3T100	S-TGZXZ1
KAI-2T150	S-4J56SQ	KAI-3T150	S-Y8CR63
KAI-2T200	S-76TK9P	KAI-3T200	S-842RRP
KAI-2T150/480	S-J1YLR6	KAI-3T150/480	S-9FC78T
KAI-2T200/480	S-5WZGVH	KAI-3T200/480	S-VZ7V3J

COMPLIANCE

DLC Listing (Continued)

Model#	DLC Product ID	Model#	DLC Product ID
KAI-4T70	S-7HV98T	KAI-4T150/480	S-1N30V3
KAI-4T100	S-4FW9RS	KAI-4T200/480	S-P2MXQR
KAI-4T150	S-7KX3DM		
KAI-4T200	S-BXKJLG		

FACTORY SETTINGS

Wattage:

KAI-70: 70/60/50W (70W default)

KAI-100: 100/80/60W (100W default)

KAI-150: 150/120/100W (150W default)

KAI-200: 200/180/160W (200W default)

Lightcloud Blue models can adjust light levels with the mobile app or other devices.

Color temperature:

3000/4000/5000K (4000K default)

LED CHARACTERISTICS

LEDs

Long-life, high-efficacy, surface-mount LEDs

Color Uniformity

RAB's range of Correlated Color Temperature follows the guidelines of the American National Standards for Specifications for the Chromaticity of Solid State Lighting (SLL) Products, ANSI C78.377-2017.

TECHNICAL SPECIFICATIONS

CONSTRUCTION

Cold Weather Starting

Minimum starting temperature is -40°C (-40°F)

Maximum Ambient Temperature

Suitable for use in up to 40°C (104°F)

Housing

Die-cast aluminum housing and mounting arm

Lens

Clear polycarbonate lens

Gasket

Silicone

Mounting

Adjustable pole mount

Tilt Increment

2.5°

Vibration Rating

3G vibration rating per ANSI C136.31

BUG Rating

Catalog Number (Base)	BUG Rating
KAI-70 @50W	B2-U0-G1
KAI-70 @60W	B2-U0-G2
KAI-70 @70W	
KAI-100 @60W	B2-U0-G2
KAI-100 @80W	
KAI-100 @100W	B3-U0-G2
KAI-150 @100W	B3-U0-G3
KAI-150 @120W	
KAI-150 @150W	
KAI-200 @160W	B3-U0-G3
KAI-200 @180W	
KAI-200 @200W	B4-U0-G3
All 480V Models	B3-U0-G3

EPA (Effective Projected Area)

Small models: 0.37

Large models: 0.45

Green Technology

Includes recycled plastic and RoHS-compliant components.

Finish

Formulated for high durability and long lasting color

IES Classifications

Type II - Ideal for wide walkways, on ramps and entrance roadways, bike paths, and other long/narrow applications. This type is meant for lighting larger areas is usually located near the roadside.

Type III - Ideal for roadway, general parking, and other area lighting applications where a larger pool of lighting is required. It is intended to be located near the side of the area, allowing the light to project outward and fill the area.

Type IV - Also known as "forward throw", it is especially suited for mounting on the sides of buildings and walls, and for illuminating the perimeter of parking areas. It produces a semicircular distribution with essentially the same candlepower at lateral angles from 90° to 270°.

ELECTRICAL

Drivers:

Constant Current, Class 1, 120-277V, 50/60 Hz

KAI-70:

70W: 120V: 0.57A, 208V: 0.33A, 240V: 0.28A, 277V: 0.25A

60W: 120V: 0.46A, 208V: 0.26A, 240V: 0.23A, 277V: 0.21A

50W: 120V: 0.38A, 208V: 0.24A, 240V: 0.21A, 277V: 0.18A

KAI-100:

100W: 120V: 0.79A, 208V: 0.46A, 240V: 0.40A, 277V: 0.35A

80W: 120V: 0.66A, 208V: 0.38A, 240V: 0.33A, 277V: 0.30A

60W: 120V: 0.49A, 208V: 0.32A, 240V: 0.27A, 277V: 0.24A

KAI-150:

150W: 120V: 1.18A, 208V: 0.68A, 240V: 0.59A, 277V: 0.52A

120W: 120V: 0.96A, 208V: 0.56A, 240V: 0.48A, 277V: 0.43A

100W: 120V: 0.83A, 208V: 0.48A, 240V: 0.41A, 277V: 0.38A

KAI-200:

200W: 120V: 1.58A, 208V: 0.91A, 240V: 0.79A, 277V: 0.70A

180W: 120V: 1.43A, 208V: 0.82A, 240V: 0.71A, 277V: 0.63A

160W: 120V: 1.28A, 208V: 0.74A, 240V: 0.64A, 277V: 0.57A

Constant Current, Class 1, Class P, 480V, 50/60 Hz

KAI-150:

150W: 480V: 0.31A

120W: 480V: 0.25A

100W: 480V: 0.22A

KAI-200:

200W: 480V: 0.41A

180W: 480V: 0.38A

160W: 480V: 0.34A

Dimming Driver

Driver includes dimming control wiring for 0-10V dimming systems.

Requires separate 0-10V DC dimming circuit. Dims down to 10%.

Note: Lightcloud Blue models do not require a 0-10V dimming circuit.

THD/Power factor:

Model#	Type	THD (120V)	PF (120V)	THD (277V)	PF (277V)	THD (480V)	PF (480V)
KAI70	2T	6.4%	99.7%	10.6%	95.6%		
KAI70	3T	6.3%	99.7%	10.5%	95.6%		
KAI70	4T	6.4%	99.7%	10.6%	95.6%		
KAI100	2T	7.2%	99.6%	11.0%	95.6%		
KAI100	3T	7.0%	99.6%	10.8%	95.6%		
KAI100	4T	7.0%	99.6%	10.8%	95.6%		
KAI150	2T	5.0%	99.8%	7.6%	96.0%	5.4%	95.9%
KAI150	3T	5.0%	99.8%	7.6%	96.1%	5.4%	95.9%
KAI150	4T	5.0%	99.8%	7.6%	96.1%	5.4%	95.9%
KAI200	2T	4.8%	99.8%	5.7%	96.5%	7.3%	95.9%
KAI200	3T	4.8%	99.8%	5.7%	96.5%	7.3%	95.9%
KAI200	4T	4.8%	99.8%	5.6%	96.5%	7.4%	95.9%

Surge Protection

10kV standard & 20kV optional accessory.

OTHER

Warranty

The RAB 10-year, limited warranty covers light output, driver performance and paint finish. RAB's warranty is subject to all terms and conditions found at rablighting.com/warranty.

Lifespan

100,000-hour LED lifespan based on IES LM-80 results and TM-21 calculations

WIRELESS NETWORK LIGHTING CONTROLS

Lightcloud products offer integrated network lighting control for a truly wireless solution that allows you to manage RAB's various compatible devices. With RAB's patented Rapid Provisioning technology, devices can be quickly and easily commissioned for residential and commercial applications. Each device can communicate with other devices in the mesh network. With two Lightcloud systems to choose from, it's easy to implement controls anywhere.



Learn more about Lightcloud wireless networked lighting controls.

Design Lights Consortium Network Lighting Controls:

- Interior Applications: N1XMLOEATB
- Exterior Applications: NHCZ2BIA17L

Lightcloud®

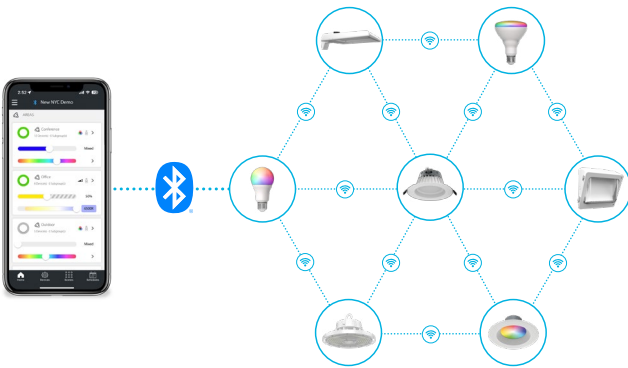

- Utilizes Bluetooth Mesh, eliminating the need for a Gateway or Hub
- Ideal for applications that need basic wireless control such as ON/OFF, dimming, color tuning, Schedules, and SmartShift
- Download the Lightcloud Blue mobile app for iOS or Android devices
- Add the XDIM/BRIDGE/LCB and LCGATEWAY to adopt premium Lightcloud Enterprise features

SIMPLE SETUP

- 1** Download the app.
- 2** Connect product to power.
- 3** Pair product to app.
- 4** Enjoy!

Learn more about [Lightcloud Blue](#). Visit the [Lightcloud Blue Resources](#) page for more information on how to use the system.

Lightcloud®

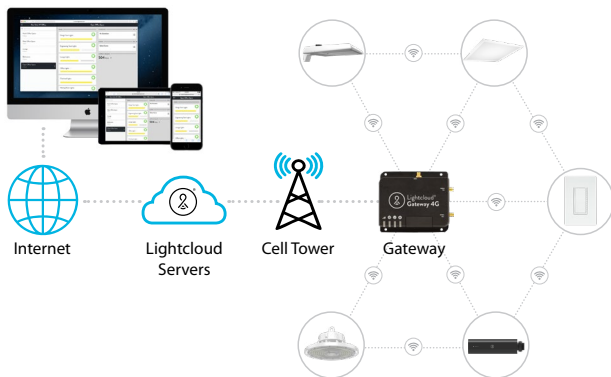

- Utilizes a secure cellular and Zigbee mesh network that requires a Gateway or Hub (sold separately)
- Offers premium features like remote commissioning, demand response, BACnet integration, and more
- Download the Lightcloud Enterprise mobile app for iOS or Android devices

SIMPLE SETUP

- 1** Download the app.
- 2** Complete the startup document.
- 3** Connect product to power.
- 4** Contact RAB for Remote Commissioning.
- 5** Enjoy!

Learn more about [Lightcloud Enterprise](#). Visit the [Lightcloud Enterprise Resources](#) page for more information on how to use the system.

KAI Field-Adjustable Cobra Head



DIMENSIONS

KAI-70 / KAI-100

MODEL# (Base)	WEIGHT
KAI-70	6.64 lbs
KAI-100	6.64 lbs

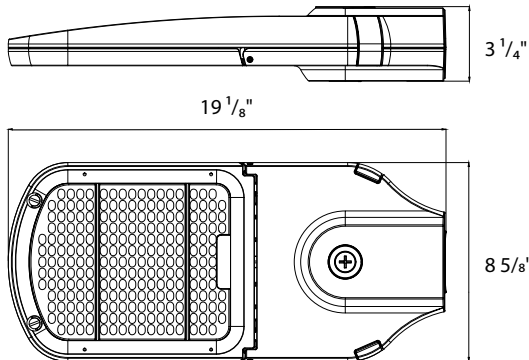

KAI-150 / KAI-200

MODEL# (Base)	WEIGHT
KAI-150	6.86 lbs
KAI-150/480	10.52 lbs
KAI-200	6.97 lbs
KAI-200/480	10.65 lbs

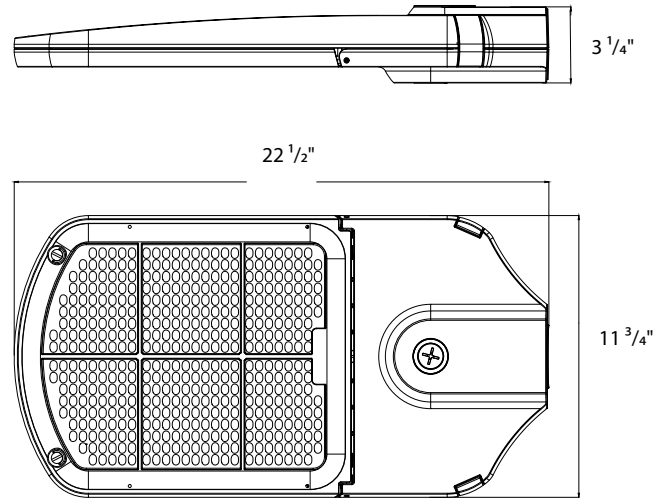

















ACCESSORIES

IMAGE	CATALOG#	UPC	DESCRIPTION
	R-3P-PCT	192552004299	3 PIN TWISTLOCK PHOTOCELL 120V-277V
	R-3P-PCT-480V	192552004305	3 PIN TWISTLOCK PHOTOCELL 480V
	LCTWIST/K	019813832111	Light Cloud twistlock photocell
	MSR1	192552026055	MULTI SENSOR REMOTE CONTROL IP20
	SP20KV-277	192552055079	KAI SURGE PROTECTOR 20KV 120V -277V
	SP20KV-480	192552055086	KAI SURGE PROTECTOR 20KV 480V

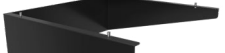
KAI Field-Adjustable Cobra Head



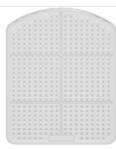



ACCESSORIES

IMAGE	CATALOG#	UPC	DESCRIPTION
	KAI-70/100SS	192552053785	COBRAHEAD KAI 70W TO 100W 4-SIDED SHIELD BRONZE
	KAI-70/100SSG	192552053815	COBRAHEAD KAI 70W TO 100W 4-SIDED SHIELD ROADWAY GRAY
	KAI-150/200SS	192552053846	COBRAHEAD KAI 150W TO 200W 4-SIDED SHIELD BRONZE
	KAI-150/200SSG	192552053877	COBRAHEAD KAI 150W TO 200W 4-SIDED SHIELD ROADWAY GRAY
	KAI-70/100FS	192552053761	COBRAHEAD KAI 70W TO 100W FRONT SIDE SHIELD BRONZE
	KAI-70/100FSG	192552053792	COBRAHEAD KAI 70W TO 100W FRONT SIDE SHIELD ROADWAY GRAY
	KAI-150/200FS	192552053822	COBRAHEAD KAI 150W TO 200W FRONT SIDE SHIELD BRONZE
	KAI-150/200FSG	192552053853	COBRAHEAD KAI 150W TO 200W FRONT SIDE SHIELD ROADWAY GRAY
	KAI-70/100HS	192552053778	COBRAHEAD KAI 70W TO 100W HOUSE SIDE SHIELD BRONZE
	KAI-70/100HSG	192552053808	COBRAHEAD KAI 70W TO 100W HOUSE SIDE SHIELD ROADWAY GRAY
	KAI-150/200HS	192552053839	COBRAHEAD KAI 150W TO 200W HOUSE SIDE SHIELD BRONZE
	KAI-150/200HSG	192552053860	COBRAHEAD KAI 150W TO 200W HOUSE SIDE SHIELD ROADWAY GRAY
	KAI-70/100LENS2T	192552053891	TYPE II LENS KIT COBRAHEAD KAI 70W TO 100W
	KAI-70/100LENS4T	192552053907	TYPE IV LENS KIT COBRAHEAD KAI 70W TO 100W
	KAI-70/100LENS3T	192552058391	TYPE III LENS KIT COBRAHEAD KAI 150W TO 200W
	KAI-150/200LENS3T	192552058407	TYPE III LENS KIT COBRAHEAD KAI 150W TO 200W

KAI Field-Adjustable Cobra Head

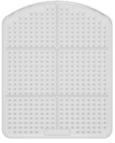

ACCESSORIES

IMAGE	CATALOG#	UPC	DESCRIPTION
	KAI-150/200LENS2T	192552053914	TYPE II LENS KIT COBRAHEAD KAI 150W TO 200W
	KAI-150/200LENS4T	192552053921	TYPE IV LENS KIT COBRAHEAD KAI 150W TO 200W
	KAI-SF-KIT	192552053747	COBRAHEAD KAI SLIPFITTER KIT BRONZE
	KAI-SF-KIT/G	192552053754	COBRAHEAD KAI SLIPFITTER KIT ROADWAY GRAY
	KAI-MC	192552053884	COBRAHEAD KAI MOUNTING CLAMP FOR 1" TO 1 1/4" POLE ARM

ORDERING MATRIX

KAI														
Family	Distribution Type	Wattage		Mounting		Color Temperature		Finish		Driver		Controls		
KAI	-													
	2T	Type II	70	70/60/50W	BLANK	Adjustable Pole Mount	BLANK	3000/4000/5000K	BLANK	Bronze	BLANK	120-277V,	BLANK	No Option
	3T	Type III	100	100/80/60W					RG	Roadway Gray	0-10V Dimming	480V,	/7PRS	7-Pin Receptacle w/Shorting Cap
	4T	Type IV	150	150/120/100W							0-10V Dimming	/480*	/LCBS	Lightcloud Blue w/PIR Sensor
			200	200/180/160W									/LCBS/MVS	Lightcloud Blue w/MVS Sensor

*480V available on 150W & 200W models only