

INSTRUCTIONS

CCT-Adjustable Trimless Gimbal Downlight



RAB Lighting is committed to creating high-quality, affordable, well-designed and energy-efficient LED lighting and controls that make it easy for electricians to install and end users to save energy. We'd love to hear your comments. Please call the Marketing Department at 888-RAB-1000 or email: marketing@rablighting.com



GR2TL



GR3TL



GR4TL

IMPORTANT

READ CAREFULLY BEFORE INSTALLING FIXTURE. RETAIN THESE INSTRUCTIONS FOR FUTURE REFERENCE.

RAB fixture must be wired in accordance with the National Electrical Code and all applicable local codes. Proper grounding is required for safety. THIS PRODUCT MUST BE INSTALLED IN ACCORDANCE WITH THE APPLICABLE INSTALLATION CODE BY A PERSON FAMILIAR WITH THE CONSTRUCTION AND OPERATION OF THE PRODUCT AND THE HAZARDS INVOLVED.

TO PREVENT ELECTRICAL SHOCK, POWER SHOULD BE TURNED OFF AT THE FUSE BOX BEFORE INSTALLATION.

SAFETY WARNINGS:

Read all product labels and directions.

- **WARNING – Risk of fire or electric shock.** Install this kit only in the luminaires that have the construction features and dimensions shown in the photographs and/or drawings and where the input rating of the retrofit kit does not exceed the input rating of the luminaire.
- Installation should be performed only by a qualified electrician in accordance with the National Electrical Code and relevant local codes. Do not make or alter any open holes in an enclosure of wiring or electrical components during kit installation.
- **WARNING – To prevent wiring damage or abrasion, do not expose wiring to edges of sheet metal or other sharp objects.**
- **INSTALLATION SHOULD ONLY BE PERFORMED AFTER POWER TO THE FIXTURE HAS BEEN DISCONNECTED.**
- These instructions shall be included on an information sheet packaged with each unit.
- This device complies with Part 15 of the FCC Rules. Operation is subject to the following two conditions: (1) this device may not cause harmful interference, and (2) this device must accept any interference received, including interference that may cause undesired operation.

WHAT'S IN THE BOX

2" / 3"

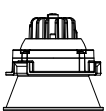

Fixture (1)

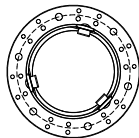

Trim (1)



Template (1)

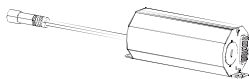

Driver Box (1)



Screws (6)

4"

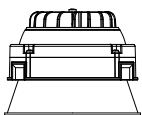

Fixture (1)

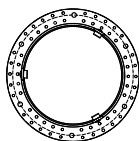

Trim (1)



Template (1)



Driver Box (1)



Screws (6)

DIMENSIONAL DRAWINGS

2" / 3"

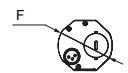
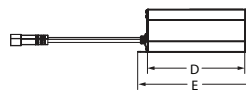
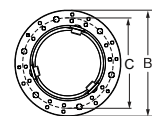
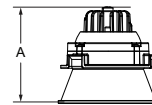

DIMENSIONS	A	B	C	D	E	F
2" ROUND	2 1/16	3 1/2	3	4 1/2	5	2
3" ROUND	2 9/16	4 1/16	4	4 1/2	5	2

4"

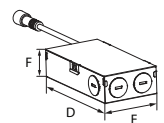
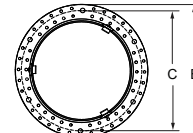
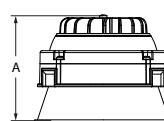

DIMENSIONS	A	B	C	D	E	F
4" ROUND	3 1/4	5 7/16	4 1/16	4 9/10	2 1/2	1 1/2

INSTRUCTIONS

CCT-Adjustable Trimless Gimbal Downlight



RAB Lighting is committed to creating high-quality, affordable, well-designed and energy-efficient LED lighting and controls that make it easy for electricians to install and end users to save energy. We'd love to hear your comments. Please call the Marketing Department at 888-RAB-1000 or email: marketing@rablighting.com

INSTALLATION INSTRUCTIONS

1. Turn power OFF from the electrical panel before installation.
2. Use template included in the box to cut a hole in the ceiling.
(Fig. 1)

Fig: 1

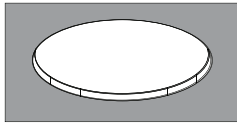

See below size of the cutout template:
2" models: 2-5/8 diameter
3" models: 3" diameter
4" models: 4-5/16" diameter

3. Place the trim onto the ceiling. Fasten to ceiling with screws.
(Fig.2)

Fig: 2

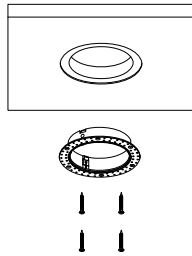

4. Patch over the trim with stucco or plaster and paint with desired color. (Fig.3)

Fig: 3

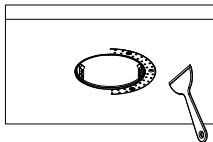

5. Open the driver box and remove the needed knockout(s). (Fig. 4)

Fig: 4

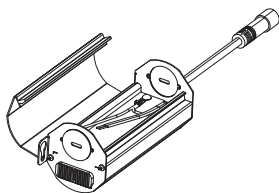

6. Insert the electrical supply cable through the knockout and secure with a cable connector. Wire driver box (Fig. 5).

Fig: 5

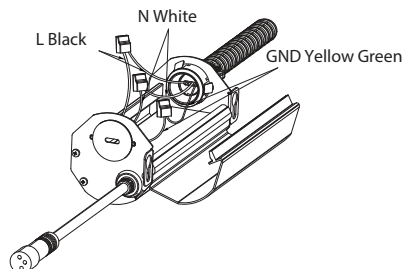

INSTALLATION INSTRUCTIONS (cont'd)

7. Place all wiring and connections back into the driver box and close the cover and select the desired color temperature (CCT).
(Fig. 6)

Fig: 6

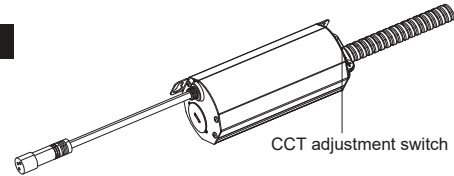

8. Place the driver box into the ceiling and connect the fixture to the driver using the twist lock connector. Once connected, turn clockwise to lock into place. (Fig. 7)

Fig: 7

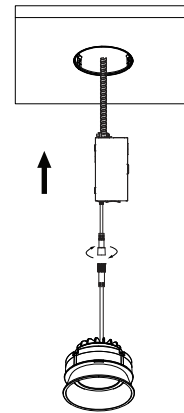

9. Place the driver box into the ceiling and connect the fixture to the driver box by twisting the twist lock connector clockwise to lock into place.(Fig. 8)

Fig: 8

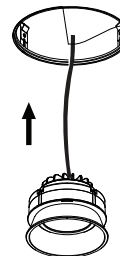

10. Installation complete. (Fig. 9)

Fig: 9

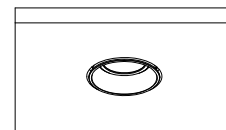

Note: These instructions do not cover all details or variations in equipment nor do they provide for every possible situation during installation, operation or maintenance.



Easy Answers

rablighting.com
Visit our website for product info

Tech Help Line
Call our experts: 888 722-1000

e-mail
Answered promptly - sales@rablighting.com

Free Lighting Layouts
Answered online or by request

INSTRUCTIONS

CCT-Adjustable Trimless Recessed Downlight



RAB Lighting is committed to creating high-quality, affordable, well-designed and energy-efficient LED lighting and controls that make it easy for electricians to install and end users to save energy. We'd love to hear your comments. Please call the Marketing Department at 888-RAB-1000 or email: marketing@rablighting.com



R2TL



R3TL



R4TL

IMPORTANT

READ CAREFULLY BEFORE INSTALLING FIXTURE. RETAIN THESE INSTRUCTIONS FOR FUTURE REFERENCE.

RAB fixture must be wired in accordance with the National Electrical Code and all applicable local codes. Proper grounding is required for safety. THIS PRODUCT MUST BE INSTALLED IN ACCORDANCE WITH THE APPLICABLE INSTALLATION CODE BY A PERSON FAMILIAR WITH THE CONSTRUCTION AND OPERATION OF THE PRODUCT AND THE HAZARDS INVOLVED.

TO PREVENT ELECTRICAL SHOCK, POWER SHOULD BE TURNED OFF AT THE FUSE BOX BEFORE INSTALLATION.

SAFETY WARNINGS:

Read all product labels and directions.

- **WARNING – Risk of fire or electric shock.** Install this kit only in the luminaires that have the construction features and dimensions shown in the photographs and/or drawings and where the input rating of the retrofit kit does not exceed the input rating of the luminaire.
- Installation should be performed only by a qualified electrician in accordance with the National Electrical Code and relevant local codes. Do not make or alter any open holes in an enclosure of wiring or electrical components during kit installation.
- **WARNING – To prevent wiring damage or abrasion, do not expose wiring to edges of sheet metal or other sharp objects.**
- **INSTALLATION SHOULD ONLY BE PERFORMED AFTER POWER TO THE FIXTURE HAS BEEN DISCONNECTED.**
- These instructions shall be included on an information sheet packaged with each unit.
- This device complies with Part 15 of the FCC Rules. Operation is subject to the following two conditions: (1) this device may not cause harmful interference, and (2) this device must accept any interference received, including interference that may cause undesired operation.

WHAT'S IN THE BOX

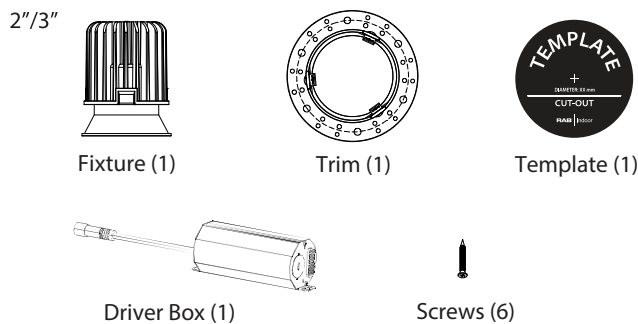

DIMENSIONAL DRAWINGS

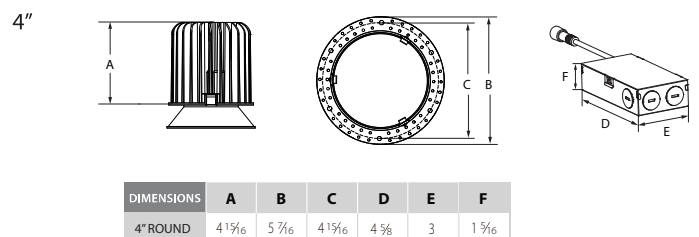
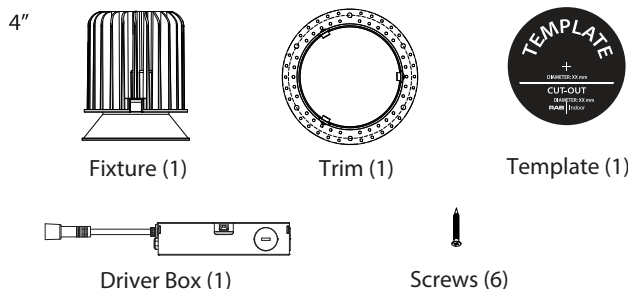
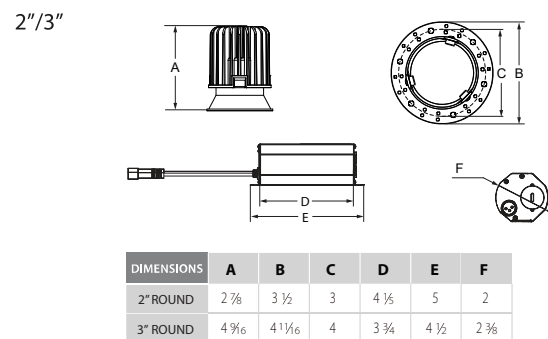

INSTRUCTIONS

CCT-Adjustable Trimless Recessed Downlight



RAB Lighting is committed to creating high-quality, affordable, well-designed and energy-efficient LED lighting and controls that make it easy for electricians to install and end users to save energy. We'd love to hear your comments. Please call the Marketing Department at 888-RAB-1000 or email: marketing@rablighting.com

INSTALLATION INSTRUCTIONS

1. Turn power OFF from the electrical panel before installation.
2. Use template included in the box to cut a hole in the ceiling. (Fig. 1)

Fig: 1

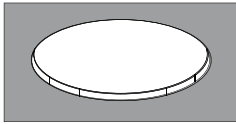

See below size of the cutout template:
2" models: 2-5/8" diameter
3" models: 3" diameter
4" models: 4-5/16" diameter

3. Place the trim onto the ceiling. Fasten to ceiling with screws. (Fig.2)

Fig: 2

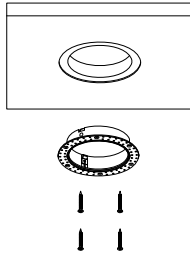

4. Patch over the trim with stucco or plaster and paint with desired color. (Fig.3)

Fig: 3

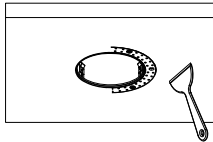

5. Open the driver box and remove the needed knockout(s). (Fig.4)

Fig: 4

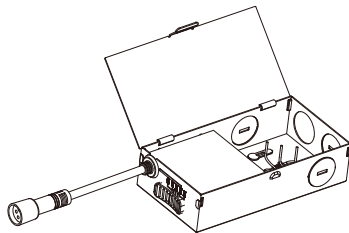

6. Insert the electrical supply cable through the knockout and secure with a cable connector. Wire driver box (Fig. 5).

Fig: 5

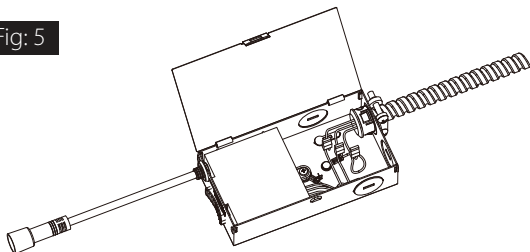

INSTALLATION INSTRUCTIONS (cont'd)

7. Place all wiring and connections back into the driver box and close the cover and select the desired color temperature (CCT). (Fig. 6)

Fig: 6

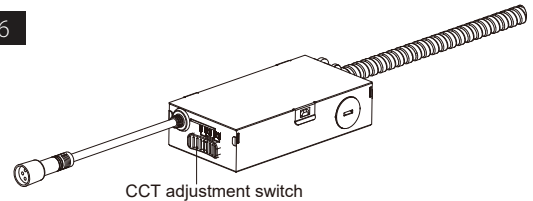

8. Place the driver box into the ceiling and connect the fixture to the driver using the twist lock connector. Once connected, turn clockwise to lock into place. (Fig. 7)

Fig: 7

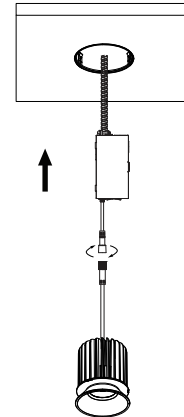

9. Place the driver box into the ceiling and connect the fixture to the driver box by twisting the twist lock connector clockwise to lock into place.(Fig. 8)

Fig: 8

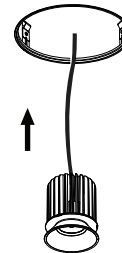

10. Installation complete. (Fig. 9)

Fig: 9

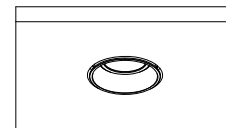

Note: These instructions do not cover all details or variations in equipment nor do they provide for every possible situation during installation, operation or maintenance.



Easy Answers

rablighting.com
Visit our website for product info

Tech Help Line
Call our experts: 888 722-1000

e-mail
Answered promptly - sales@rablighting.com

Free Lighting Layouts
Answered online or by request