

**RAB**

**EZPAN**<sup>®</sup>

More options, same incredible energy savings and price.

The affordable, ultra-low-profile LED panel is available in 2'x2', 2'x4' and now 1'x4'.

# EDGE-LIT PANELS



RAB's warranty is subject to all terms and conditions found at [rablighting.com/warranty](http://rablighting.com/warranty)

- Ultra efficient, up to 126 lm/W, reducing energy costs by up to 73%
- Perfect for shallow plenums
- Even and diffuse ambient illumination, ideal for spaces where glare-free lighting is required
- Offered in three sizes and five wattages:  
1x4 (17W,30W and 40W), 2x2 (17W, 30W and 40W) and 2x4 (30W, 40W and 50W)
- 0-10V dimmable driver, standard
- Emergency battery backup option available
- Available with factory-installed Lightcloud lighting control system Controller
- Microwave occupancy sensor available
- Available with integrated SmartShift™ circadian control



SmartShift-enabled EZPANs will adjust light levels and color temperature to match the natural pattern of the sun...a soft glow in the morning, energizing light during the day, and a warm hue in the evening.



An NEC-compliant junction box with flying leads makes wiring as simple as twisting a few wire nuts, and integral T-bar clips secure EZPAN to standard T-bar systems.

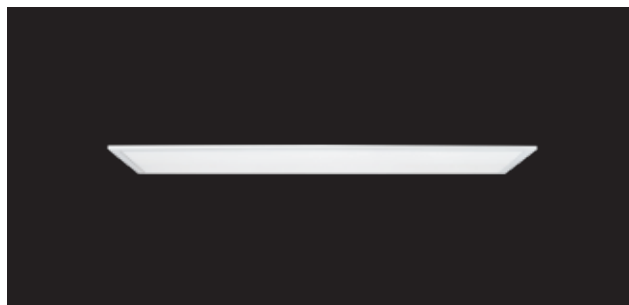

With a height just under 2", the EZPAN is an ideal solution for shallow plenums.

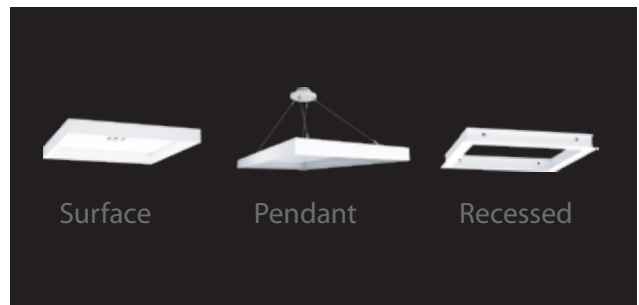

The EZPAN is available in three standard sizes (1x4, 2x2 and 2x4) for use in T-bar grids. We also offer three mounting kits for surface, pendant and recessed applications.

## Performance - EZPAN

	40W				30W				17W			
	5000K	4000K	3500K	3000K	5000K	4000K	3500K	3000K	5000K	4000K	3500K	3000K
<b>1 x 4</b>												
<b>Input Watts</b>	40	40	40	40	31	31	31	31	20	20	20	20
<b>Lumens</b>	4,829	4,753	4,691	4,516	3,705	3,693	3,662	3,630	2,327	2,255	2,300	2,280
<b>Efficacy (lm/W)</b>	120	118	118	113	119	119	119	117	117	117	116	114
<b>Color Accuracy (CRI)</b>	85	82	83	81	85	82	83	81	85	82	83	82
<b>2 x 2</b>												
<b>Input Watts</b>	40	40	40	40	32	32	31	31	17	17	17	17
<b>Lumens</b>	5,042	4,919	4,993	4,835	3,771	3,816	3,728	3,695	1,984	1,978	1,943	1,944
<b>Efficacy (lm/W)</b>	126	122	124	120	119	119	119	117	117	117	115	115
<b>Color Accuracy (CRI)</b>	85	82	83	82	85	82	84	82	85	82	84	82
<b>2 x 4</b>												
<b>Input Watts</b>	49	49	49	49	42	42	41	40	32	32	32	31
<b>Lumens</b>	5,678	5,505	5,569	5,487	4,650	4,706	4,597	4,431	3,783	3,828	3,740	3,679
<b>Efficacy (lm/W)</b>	115	113	114	112	112	112	112	111	119	119	119	118
<b>Color Accuracy (CRI)</b>	85	82	94	81	85	82	83	82	85	82	84	83

*Performance data is based on test performed at 120V.*

## Performance - EZPAN with SmartShift

Note: SmartShift is the most advanced—yet easiest to use—circadian lighting system, which syncs white color tuning with the local sunrise and sunset. SmartShift is configurable down to the individual fixture for precision control and customization.

	2700K - 6000K		2700K - 6000K		2700K - 6000K
<b>1 x 4</b>		<b>2 x 2</b>		<b>2 x 4</b>	
<b>Input Watts</b>	45.8 - 46.5	<b>Input Watts</b>	45.5 - 46.6	<b>Input Watts</b>	46 - 47.6
<b>Lumens</b>	5,123 - 5,335	<b>Lumens</b>	5,265 - 5,747	<b>Lumens</b>	5,517 - 5,929
<b>Efficacy (lm/W)</b>	111.6 - 114.9	<b>Efficacy (lm/W)</b>	115.3 - 123.7	<b>Efficacy (lm/W)</b>	119.8 - 125.1
<b>Color Accuracy (CRI)</b>	83 - 87	<b>Color Accuracy (CRI)</b>	82 - 86	<b>Color Accuracy (CRI)</b>	82 - 86

## Dimensions and weights

**EZPAN 2x4 - Weights Standard:** 10.63 lbs

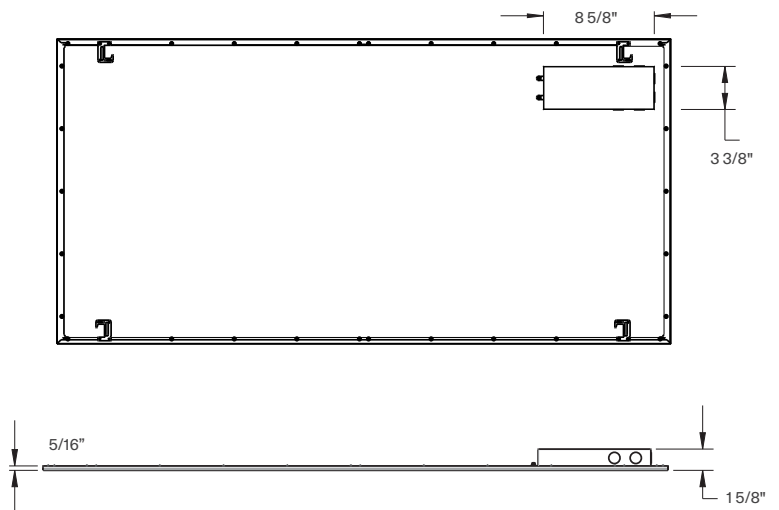
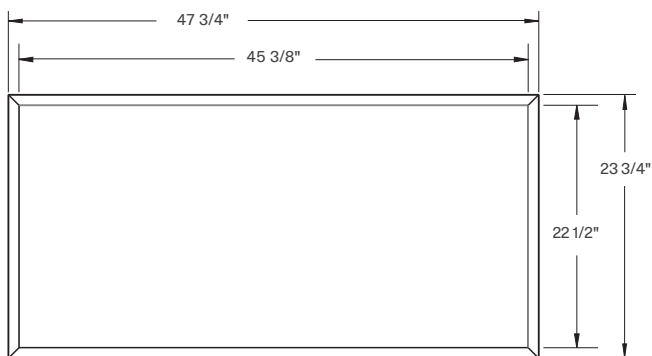

# Dimensions and weights (Cont.)

**EZPAN 2x2**  
Weights  
Standard: 6.22 lbs

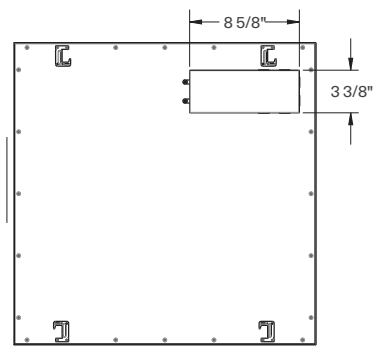
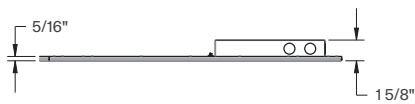
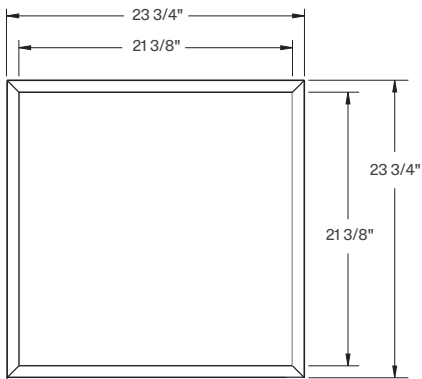

**EZPAN 1x4**  
Weights  
Standard: 6.24 lbs

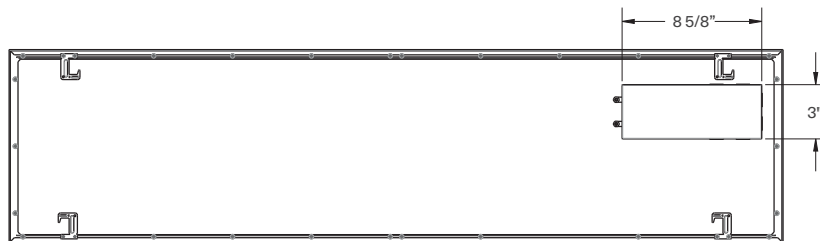
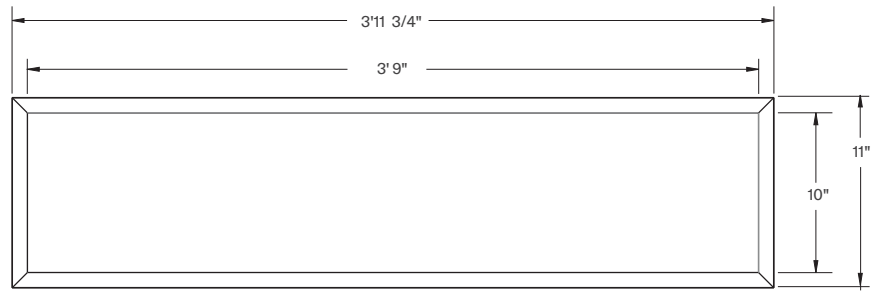

## Mounting Accessory Kits

### Surface Mounting Kits

- SMKEZPAN - 1X4 Surface Mounting Kit
- SMEKZPAN - 2X2 Surface Mounting Kit
- SMKEZPAN - 2X4 Surface Mounting Kit

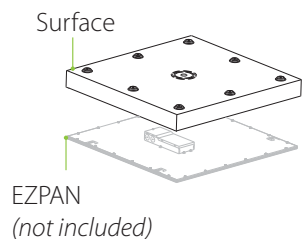

### Pendant Mounting Kits

- PMKEZPAN - 1X4 Pendant Mounting Kit
- PMKEZPAN - 2X2 Pendant Mounting Kit
- PMKEZPAN - 2X4 Pendant Mounting Kit

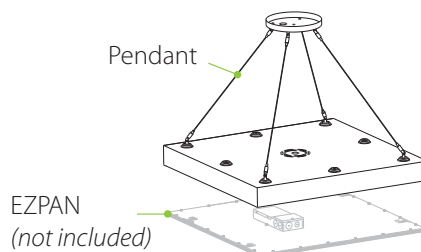

### Recessed Drywall Mounting Kits

- RMKPANEL - 1X4 Recessed Mounting Kit
- RMKPANEL - 2X2 Recessed Mounting Kit
- RMKPANEL - 2X4 Recessed Mounting Kit

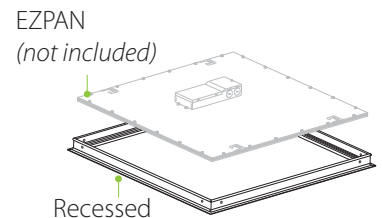

# Ordering information

Product Family	Size	Wattage	Color Temp.	Dimming (standard)	Control Options	Other Options
EZPAN				/D10		
	<b>2X4</b> 2' x 4' <b>2X2</b> 2' x 2' <b>1X4</b> 1' x 4'	<b>50</b> 50W (2' x 4') <b>40</b> 40W (2' x 4', 2' x 2', 1' x 4') <b>30</b> 30W (2' x 4', 2' x 2', 1' x 4') <b>17</b> 17W (2' x 2', 1' x 4')	<b>Blank</b> 5000K <b>N</b> 4000K <b>YN</b> 3500K <b>Y</b> 3000K	<b>/D10</b> 0-10V Dimming	<b>Blank</b> No sensor <b>/LC</b> Lightcloud Controller	<b>Blank</b> None <b>/E2</b> Emergency Battery Backup

Product Family	Size	Dimming (standard)	Smart	Control Options
EZPAN		/D10	/SS	/LC
SmartShift	<b>2X4</b> 2' x 4' <b>2X2</b> 2' x 2' <b>1X4</b> 1' x 4'	<b>/D10</b> 0-10V Dimming	<b>/SS</b> SmartShift	<b>/LC</b> Lightcloud Controller

Product Family	Size
SMKEZPAN	
Surface Mount Kit	<b>2X4</b> 2' x 4' <b>2X2</b> 2' x 2' <b>1X4</b> 1' x 4'

Product Family	Size
PMKEZPAN	
Pendant Mount Kit	<b>2X4</b> 2' x 4' <b>2X2</b> 2' x 2' <b>1X4</b> 1' x 4'

Product Family	Size
RMKPANEL	
Recessed Mount Kit	<b>2X4</b> 2' x 4' <b>2X2</b> 2' x 2' <b>1X4</b> 1' x 4'