



IVEPARK™

Low profile, low glare.  
Edge-lit technology unlike any other.

**RAB** | Outdoor

# IVEPARK™



RAB's warranty is subject to all terms and conditions found at [rablighting.com/warranty](http://rablighting.com/warranty).

- Edge-lit technology provides uniform, low-glare distribution
- Offered in 7500lm (69W), 5500lm (45W) and 3600lm (28W) models
- Uplight models available
- Several mounting options available: Surface (*standard*), trunnion, wall, and universal pole mount (*accessories*)
- Motion sensor and Lightcloud® Controller options available
- IP66 rated for protection against limited dust and water ingress
- 100,000-Hour LED lifespan



Visit [rablighting.com](http://rablighting.com) to see which models are DLC listed.

IVEPARK



Competitor #1



Competitor #2



The IVEPARK's super-sleek design makes for a significantly lower profile.



Seamless sensor integration - no unsightly arms or sidecars required.

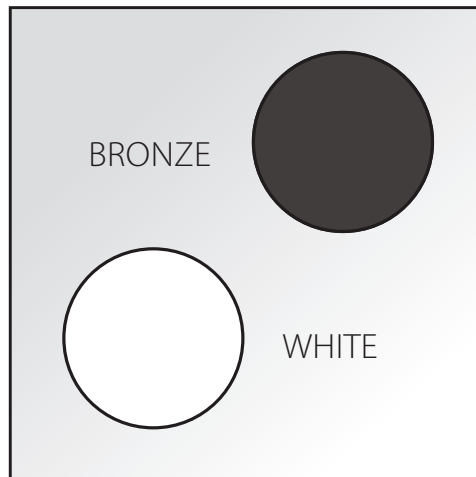

IVEPARK fixture is available in two color options: bronze or white

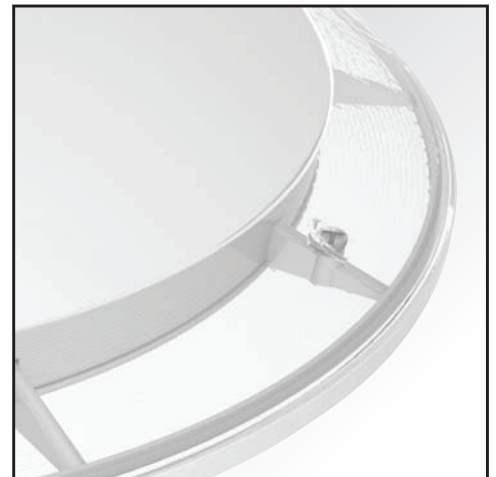

Uplight models help eliminate the "cave effect" of dark ceiling spots

## Specifications

### IVGT5-70L: Type V | 69W (Replaces 250W MH)

<b>Color Temp</b>	<b>5000K</b>	<b>4000K</b>	<b>3000K</b>
<b>Input Watts</b>	69	70	69
<b>Output Lumens</b>	7703	7378	7216
<b>Lumens Per Watt</b>	111	106	105
<b>Color Accuracy (CRI)</b>	76	75	71

### IVGT5-50L: Type V | 45W (Replaces 150W MH)

<b>Color Temp</b>	<b>5000K</b>	<b>4000K</b>	<b>3000K</b>
<b>Input Watts</b>	45	45	45
<b>Output Lumens</b>	5730	5489	5415
<b>Lumens Per Watt</b>	128	121	121
<b>Color Accuracy (CRI)</b>	76	75	72

### IVGT5-30L: Type V | 28W (Replaces 100W MH)

<b>Color Temp</b>	<b>5000K</b>	<b>4000K</b>	<b>3000K</b>
<b>Input Watts</b>	29	29	28
<b>Output Lumens</b>	3724	3567	3489
<b>Lumens Per Watt</b>	131	125	124
<b>Color Accuracy (CRI)</b>	76	75	71

## Photometrics

### IVGT5-50L: Type V | 45W

10' Mounting height  
Photometric Report: DLF1811104-5a

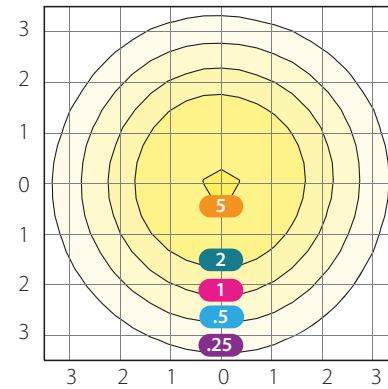

### IVGT5C-50L: Type V Concentrated | 45W

10' Mounting height  
Photometric Report: DLF1811104-6a

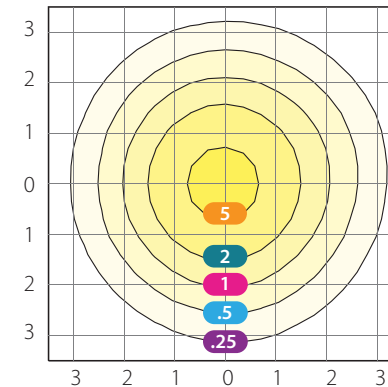

**UL:**  
Suitable for wet locations

**LEDs:**  
Long-life, high-efficiency, micro-power, surface-mount LEDs

**Driver(s):**  
Class 2 50/60Hz, 120-277V, 4kV standard, 10kV optional

**Dimming Driver:**  
Driver includes dimming control wiring for 0-10V dimming systems. Requires separate 0-10V DC dimming circuit. Dims as low as 10%.

**Lifespan:**  
Up to 100,000-hour LED lifespan based on IES LM-80 results and TM-21 calculations

**IP Rating:**  
Ingress Protection rating of IP66 for dust and water

**Cold Weather Starting:**  
Minimum starting temperature is -20°C (-4°F);  
Emergency backup option minimum temp is 10°C (50°F)

**Maximum Ambient Temperature:**  
Suitable for use in 40°C (104°F)

**Housing:**  
Polycarbonate and aluminum housing

**Mounting:**  
Surface mount standard (*accessories available for wall, pole and trunnion mount*)

**Lens:**  
Diffused Polymethyl Methacrylate (PMMA)

**Color Stability:**  
LED color temperature is warranted to shift no more than 200K in CCT over a 5-year period

**Color Uniformity:**  
RAB's range of CCT (*Correlated Color Temperature*) follows the guidelines of the American National Standard for Specifications for the Chromacity of Solid State Lighting (SSL) Products, ANSI C78.377-2017

**Title 24 Compliant:**  
An IVEPARK edge-lit garage fixture with a WS2 control option can be used to comply with 2016 Title 24 Part 6 Section 130.2 (*a,b,c*)

**Finish:**  
Formulated for high-durability and long-lasting color

**Green Technology:**  
Mercury and UV free. RoHS-compliant components

**IESNA LM-79:**  
RAB LED luminaires and LED components have been tested by an independent laboratory in accordance with IESNA LM-79

# Dimensions and Weights

## IVGT5 - Surface Mount (standard)

Weight: 11.4 lbs (5.2 kg)

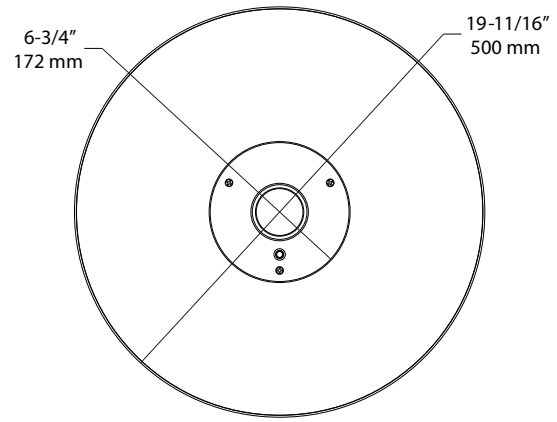
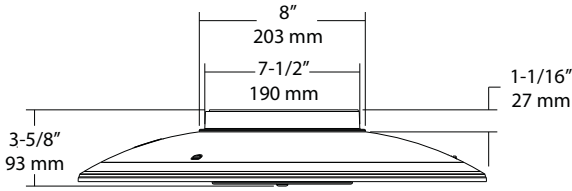

## MOUNTING Accessories (ordered separately)

### IVGYK(x) - Trunnion Mount

Weight: 16.0 lbs (7.2 kg)

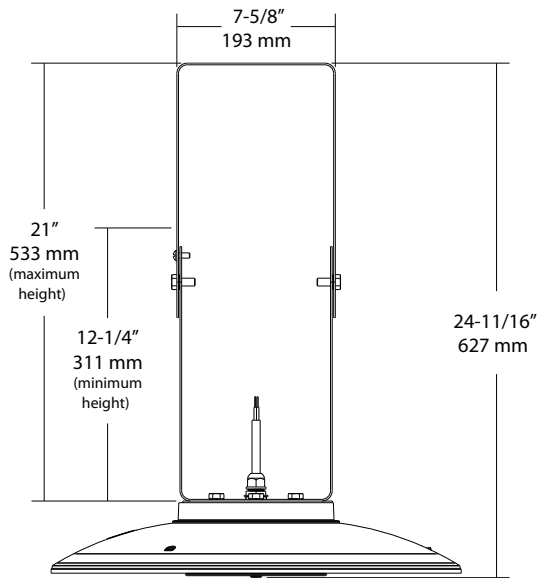

### IVGWF(x) - Wall Mount

Weight: 21.2 lbs (9.6 kg)

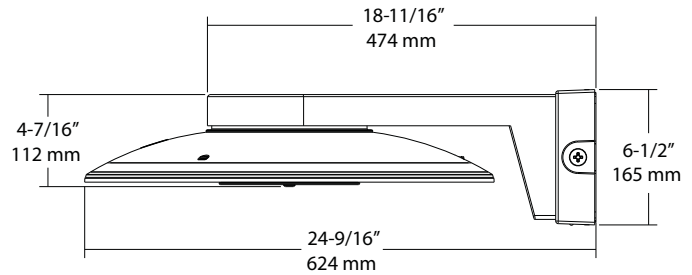

### IVGPA(x) - Universal Pole Adapter

Weight: 18.8 lbs (8.5 kg)

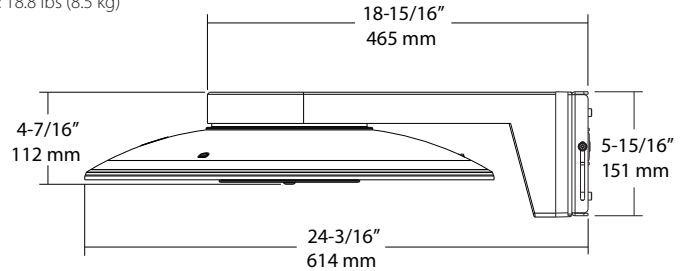

## Ordering information

Product Family	Optics/Distribution	Lumen Output/Wattages	CCT/CRI	Finish	Voltage/Driver	Sensor Options	Lightcloud*	Emergency Option
IVG								
T5	Type V Wide	30L 3600 lumens (28W)	750 5000K	Z Bronze <sup>1</sup>	U 120-277V, 0-10V Dimming	Blank /WS	No Sensor	Blank No Option
T5C	Type V Concentrated	50L 5500 lumens (45W)	740 4000K	W White	4 480V, 0-10V Dimming	/WS2	Multi-Level Motion Sensor, 8ft mounting	/LC No Option
T5U	Type V Wide with Uplight	70L 7500 lumens (69W)	730 3000K				Multi-Level Motion Sensor, 20ft mounting	/E2 Emergency <sup>2,3</sup>
T5CU	Type V Concentrated with Uplight							

## MOUNTING ACCESSORIES

**IVGBG** Bird Guard - Applies for Pendant and Trunnion Mount  
**IVG-SF** Single Fuse for 120V, 277V  
**IVG-DF** Double Fuse for 208V, 240V, 480V  
**IVGYKZ** Trunnion mount, Bronze  
**IVGYKW** Trunnion mount, White  
**IVGWFZ** Flat Wall, Bronze  
**IVGWFW** Flat Wall, White

**IVGPAZ** Universal Pole Adapter, Bronze  
**IVGPAW** Universal Pole Adapter, White  
**RSP10GI-277** 10kV Surge 120V&277V + mounting bracket  
**RSP10GI-480** 10kV Surge 480V + mounting bracket

(1) Available only for T5 and T5C distribution

(2) Applies to 120-277V

(3) Minimum operating temperature is 10°C