

INSTRUCTIONS

L34® INSTALLATION

RAB®

RAB Lighting is committed to creating high-quality, affordable, well-designed and energy-efficient LED lighting and controls that make it easy for electricians to install and end users to save energy. We'd love to hear your comments. Please call the Marketing Department at 888-RAB-1000 or email: marketing@rablighting.com

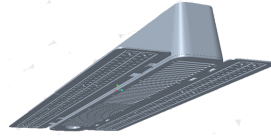

IMPORTANT

READ CAREFULLY BEFORE INSTALLING FIXTURE. RETAIN THESE INSTRUCTIONS FOR FUTURE REFERENCE.

RAB fixtures must be wired in accordance with the National Electrical Code and all applicable local codes. Proper grounding is required for safety. THIS PRODUCT MUST BE INSTALLED IN ACCORDANCE WITH THE APPLICABLE INSTALLATION CODE BY A PERSON FAMILIAR WITH THE CONSTRUCTION AND OPERATION OF THE PRODUCT AND THE HAZARDS INVOLVED.

WARNING:

- Make certain power is OFF before installing or maintaining fixture. No user serviceable parts inside.
- Suitable for damp locations.

V-HOOK MOUNTING

Mount **Housing** using **V-Hooks** (*provided*) to a sturdy ceiling structure as follows:

1. **V-Hooks** (2) are provided for mounting. Locate the long **Slot** on either end of the top **Housing** as shown in Fig. 1.
2. Squeeze the **V-Hook** and lower into the **Slot** (*Fig. 2*).
3. Release the pressure on the **V-Hook** and guide the ends of the **Hook** into position as shown in Fig. 2.
4. Ensure both ends of the **V-Hook** are secure.
5. Repeat for the other end.
6. Snap **Fixture Cover** (*provided*) into **Center Opening** (*Fig. 1*).
7. Secure the **Fixture Cover** with 2 (*provided*) 4-40SHC Screws in indicated location shown in Fig. 4.
8. Wire through the upper **Center Opening** per local and NEC code.

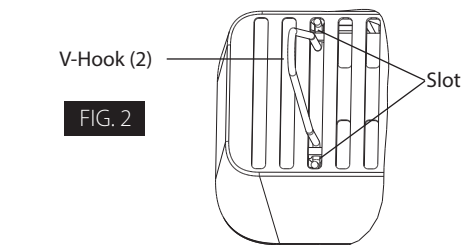
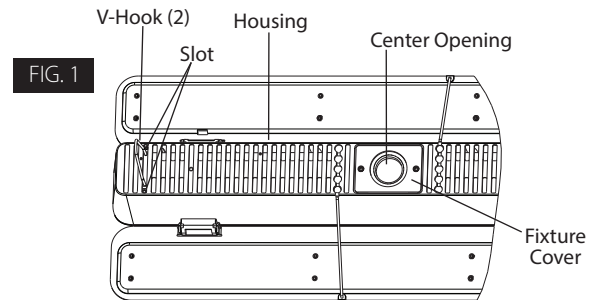

PENDANT MOUNTING

Mount **Housing** using **Pendant** (*supplied by other*) to a sturdy ceiling structure as follows:

1. Thread a **3/4" NPT Lock Nut** (*provided*) over the end of the **Pendant Stem** (*supplied by customer or installer*) as shown in Fig. 3.
2. Thread **Fixture Cover** (*supplied*) onto the **Pendant Stem**. Ensure that the **Pendant Stem** threads all the way through the **Fixture Cover** threads.
3. Feed supply wires through **Pendant Stem** and the **Fixture Cover**. Wire the housing leads to the supply wires using UL listed wire connectors according to NEC and local codes. Push all wires into the **Housing** and snap the **Fixture Cover** into the **Housing**.
4. Secure the **Fixture Cover** with 2 (*provided*) 4-40SHC Screws in indicated location shown in Fig. 4.
5. Lock the orientation of the fixture by tightening the **3/4" NPT Lock Nut** against the **Fixture Cover** as shown in Fig. 3 and Fig. 4.

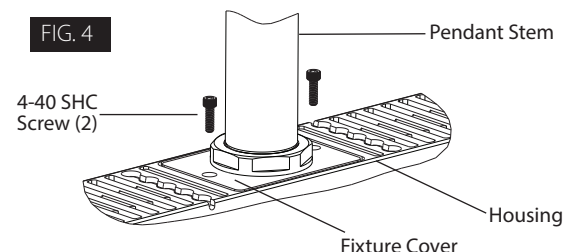
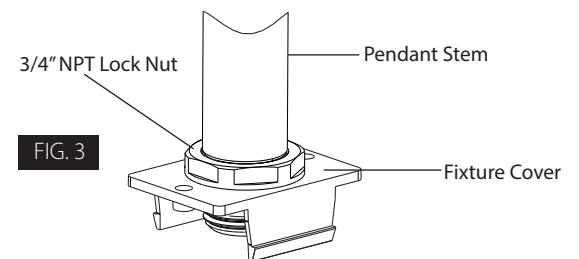

INSTRUCTIONS

L34® INSTALLATION

RAB®

RAB Lighting is committed to creating high-quality, affordable, well-designed and energy-efficient LED lighting and controls that make it easy for electricians to install and end users to save energy. We'd love to hear your comments. Please call the Marketing Department at 888-RAB-1000 or email: marketing@rablighting.com

ADJUSTING THE WING ANGLE

1. To set the **Wings** to the horizontal position, install the **Guy Wire** (*provided*) as shown in **Fig. 5** with the ball in the last round opening.
2. To set the **Wing** angle at 15°, the ball should be in the second opening as shown in **Fig. 6**.

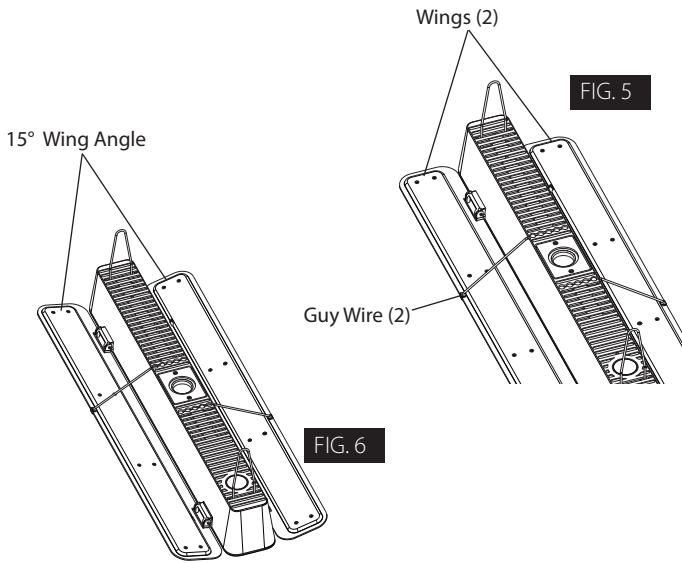

0-10V DIMMABLE WIRING

Universal voltage driver permits operation at 120V thru 277V, 50 or 60 Hz. For 0-10V Dimming, follow the wiring directions as shown **Fig. 7**.

1. Connect the black fixture lead to the LINE supply lead.
2. Connect the white fixture lead to the COMMON supply lead.
3. Connect the GROUND wire from fixture to supply ground.
4. Connect the purple fixture lead to the (V+) DIM lead.
5. Connect the gray fixture lead to the (V-) DIM lead.

NOTE: Do not connect DIM V+ (purple)/ DIM V- (gray) to line voltage or supply ground.

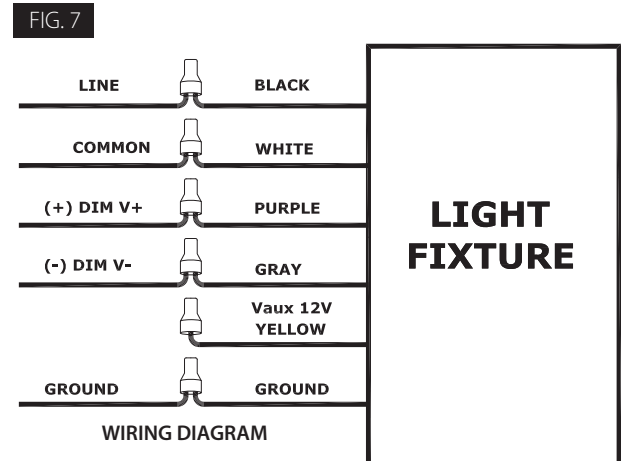

ACCESSORY KIT

Accessory Kit is provided to include the following:

- Wire Hanger / V-Hook (2)
- Guy Wire (2)
- 3/4" Lock Nut
- Fixture Cover
- 4-40 SHC Screws, White (2)

CLEANING & MAINTENANCE

CAUTION: Be sure fixture temperature is cool enough to touch. Do not clean or maintain while fixture is energized.

1. Do not touch the LED.
2. Clean fixture with non-abrasive cleaning solution.

TROUBLESHOOTING

1. Check that the line voltage at the fixture is correct.
2. Be sure the fixture is grounded properly.

Note: These instructions do not cover all details or variations in equipment nor do they provide for every possible situation during installation, operation or maintenance.

RAB®

Easy Answers

© 2021 RAB LIGHTING Inc.

rablighting.com
Visit our website for product info

Tech Help Line
Call our experts: 888 722-1000

e-mail
Answered promptly - sales@rablighting.com

Free Lighting Layouts
Answered online or by request

L34 - IN - 0521
73713-RAB