

Field-Adjustable Center Basket Troffer SWISH® FA

RAB

2X2



2X4



Driver:

Constant Current, Class 2, 120-277V, 50/60 Hz

(2x2)

19W: 0.16A @ 120V; 0.10A @ 208V, 0.08A @ 240V, 0.07A @ 277V

29W: 0.25A @ 120V; 0.15A @ 208V, 0.13A @ 240V, 0.12A @ 277V

39W: 0.33A @ 120V; 0.20A @ 208V, 0.17A @ 240V, 0.15A @ 277V

(2x4)

29W: 0.22A @ 120V; 0.15A @ 208V, 0.13A @ 240V, 0.11A @ 277V

39W: 0.33A @ 120V; 0.20A @ 208V, 0.17A @ 240V, 0.15A @ 277V

40W: 0.39A @ 120V; 0.24A @ 208V, 0.21A @ 240V, 0.17A @ 277V

Features

- Field-adjustable lumen output (3 discrete steps)
- White tunable (3 discrete color temperatures)
- Can be changed during and after installation
- Battery backup option offered
- Microwave occupancy sensor
- Available with Lightcloud Controller®

Project:

Type:

Prepared By:

Date:

Technical Specifications

UL Listing:

Suitable for dry, damp locations.
IC rated for direct contact with thermal insulation.

CCEA Compliant:

Luminaire Requirements used in Environmental Air Space per the electrical code specification of the City of Chicago

IESNA LM-79 & IESNA LM-80 Testing:

RAB LED luminaires and LED components have been tested by an independent laboratory in accordance with IESNA LM-79 and LM-80.

LEDs:

Long-life, high-efficacy, mid-power, surface-mount LEDs

Lifespan:

100,000-hour LED lifespan based on IES LM-80 results and TM-21 calculations

Cold Weather Starting:

The minimum starting temperature is -30°C (-22°F)

Ambient Temperature:

Suitable for use up to 40°C (104°F)

Lens:

Frosted polycarbonate

Mounting:

Recessed ceiling

Housing:

Die-formed, 20-gauge, cold-rolled steel

Reflector:

Integral reflector (on the sides) with high reflectance finish, optimized for uniform distribution

Final:

Formulated for high durability and long-lasting color

Green Technology:

Mercury and UV free. RoHS-compliant components

Warranty:

RAB warrants that our LED products will be free from defects in materials and workmanship for a period of five (5) years from the date of delivery to the end user, including coverage of light output, color stability, driver performance and fixture finish. RAB's warranty is subject to all terms and conditions found at rablighting.com/warranty.

Dimensions and Weight

2x2

Weight: 14 lbs

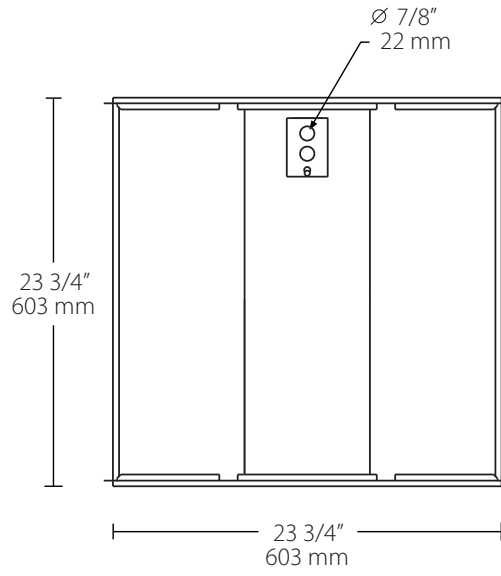

2x4

Weight: 23 lbs

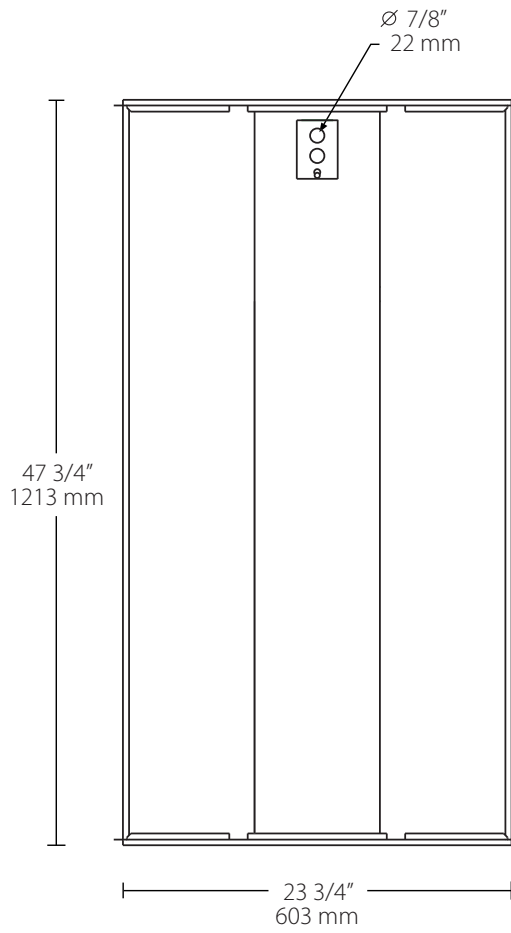

Performance





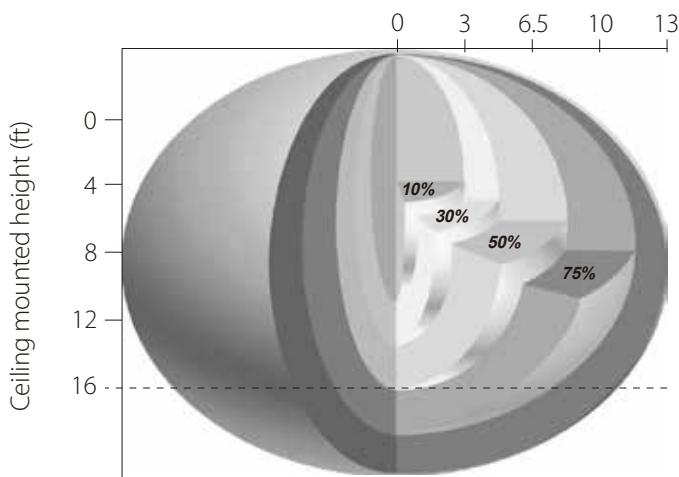

	19W			29W			39W		
	3500K <i>(Warm Neutral)</i>	4000K <i>(Neutral)</i>	5000K <i>(Cool)</i>	3500K <i>(Warm Neutral)</i>	4000K <i>(Neutral)</i>	5000K <i>(Cool)</i>	3500K <i>(Warm Neutral)</i>	4000K <i>(Neutral)</i>	5000K <i>(Cool)</i>
2 x 2									
Lumens	2432	2573	2529	3677	3954	3816	4463	4913	4691
Efficacy (lm/W)	129	139	134	123	136	128	116	133	122
Color Accuracy (CRI)	84	86	84	84	85	84	83	85	84
2 x 4									
Lumens	3484	3677	3624	4875	5263	5072	5702	5882	5806
Efficacy (lm/W)	133	144	138	125	139	130	119	137	125
Color Accuracy (CRI)	84	85	84	84	85	84	83	85	84

Detection Pattern (Ceiling mounted)



Microwave Sensor

Features

-  • 24-hour daylight monitoring dawn/dusk sensor
-  • Tri-level dimming control based upon occupancy *(also known as corridor function)*
-  • 1-10V dimming control method
-  • One-touch daylight learning via remote control
-  • Zero crossing detection circuit reduces in-rush current and prolongs relay life
-  • Loop-in and loop-out terminal for efficient installation

Ordering Matrix

Product	Size	Voltage	Options
SWISHFA	<p>2X2 2' X 2'</p> <p>2X4 2' X 4'</p>	<p>/D10 0-10V dimming</p>	<p>Blank</p> <p>/LC</p> <p>/E2</p> <p>/MVS</p> <p>No options</p> <p>Lightcloud Controller</p> <p>Battery Backup</p> <p>Occupancy Sensor</p>

Product	Size
<p>SMKPANEL</p> <p>Surface Mount Kit</p>	<p>2X2 2' X 2'</p> <p>2X4 2' X 4'</p>

Product	Size
<p>RMKPANEL</p> <p>Pendant Mount Kit</p>	<p>2X2 2' X 2'</p> <p>2X4 2' X 4'</p>