

# INSTRUCTIONS

## LED DRIVER INSTALLATION

# RAB®

RAB Lighting is committed to creating high-quality, affordable, well-designed and energy-efficient LED lighting and controls that make it easy for electricians to install and end users to save energy. We'd love to hear your comments. Please call the Marketing Department at 888-RAB-1000 or email: [marketing@rablighting.com](mailto:marketing@rablighting.com)

\*\* DON'T TOSS IT—RECYCLE IT! MAKE THE SUSTAINABLE CHOICE BY RECYCLING THIS FIXTURE AT END OF LIFE WITH A LICENSED RECYCLING PROVIDER. \*\*



TID-60



TID-96



TID/B



TOD-96



TND-96



TND/B

## IMPORTANT

### **READ CAREFULLY BEFORE INSTALLING FIXTURE. RETAIN THESE INSTRUCTIONS FOR FUTURE REFERENCE.**

RAB fixtures must be wired in accordance with the National Electrical Code and all applicable local codes. Proper grounding is required for safety. THIS PRODUCT MUST BE INSTALLED IN ACCORDANCE WITH THE APPLICABLE INSTALLATION CODE BY A PERSON FAMILIAR WITH THE CONSTRUCTION AND OPERATION OF THE PRODUCT AND THE HAZARDS INVOLVED.

1. The operation instruction does not supersede federal, state, local, or (*inter*) national laws, regulations, rules, ordinances, and codes that may apply to electrical installations.
2. The installation and electrical connection process must be operated by a professional electrician using the applicable and appropriate electrical codes.
3. Installation, usage and storage must occur in the environment within the temperature range (*usually -20~45°C for installation & usage and -20~60°C for storage*) indicated on the product datasheet of the tape light.
4. Turn off the power supply before wiring, assembly, processing, cleaning, maintenance, etc, and ensure all wiring and polarities are correct before powering on.
5. To reduce the voltage drop as much as possible, the wire length between tape light and power supply should be as short as possible.
6. Considering the reliability of the LED power supply, it's recommended to use the loading powers not exceed 80% of its rated output power.
7. This product may not be treated as household waste, dispose of the material through the waste recycling of electrical and electronic equipment.
8. LED driver used for outdoor must be installed in an approved Weatherproof Electrical Box with the corresponding protection level, according to the safety requirement of the National Electrical Code (*NEC*) in the United States.

# INSTRUCTIONS

## LED DRIVER INSTALLATION



RAB Lighting is committed to creating high-quality, affordable, well-designed and energy-efficient LED lighting and controls that make it easy for electricians to install and end users to save energy. We'd love to hear your comments. Please call the Marketing Department at 888-RAB-1000 or email: [marketing@rablighting.com](mailto:marketing@rablighting.com)  
**\*\* DON'T TOSS IT—RECYCLE IT! MAKE THE SUSTAINABLE CHOICE BY RECYCLING THIS FIXTURE AT END OF LIFE WITH A LICENSED RECYCLING PROVIDER. \*\***

### DIMENSIONAL DRAWINGS

TID-60

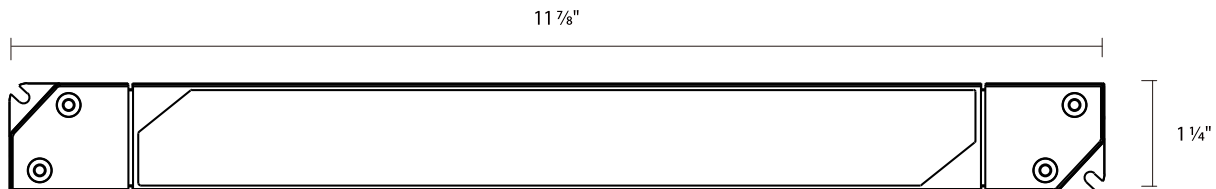

Top-View



Side-View

TID-96

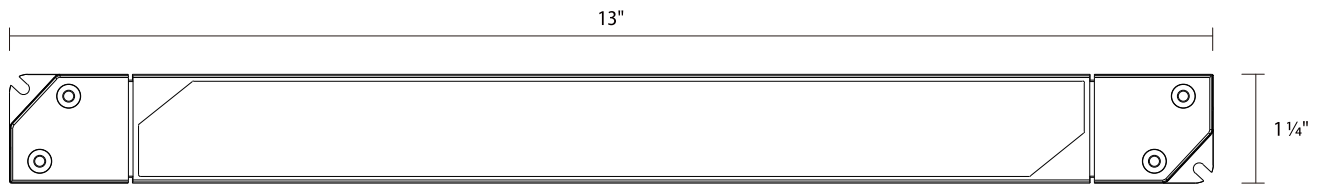

Top-View



Side-View

TID/B

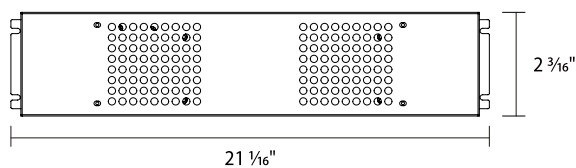

Top-View

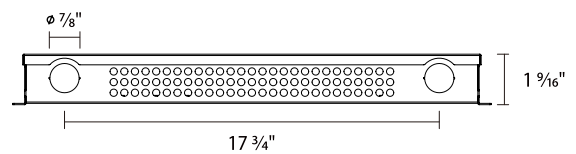

Side-View

TOD-96

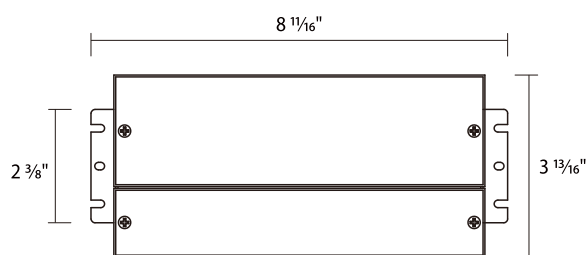

Top-View

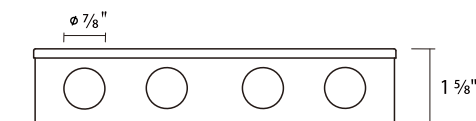

Side-View

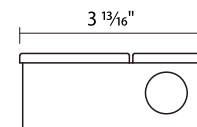

Side-View

# INSTRUCTIONS

## LED DRIVER INSTALLATION



RAB Lighting is committed to creating high-quality, affordable, well-designed and energy-efficient LED lighting and controls that make it easy for electricians to install and end users to save energy. We'd love to hear your comments. Please call the Marketing Department at 888-RAB-1000 or email: [marketing@rablighting.com](mailto:marketing@rablighting.com)  
\*\* DON'T TOSS IT—RECYCLE IT! MAKE THE SUSTAINABLE CHOICE BY RECYCLING THIS FIXTURE AT END OF LIFE WITH A LICENSED RECYCLING PROVIDER. \*\*

### DIMENSIONAL DRAWINGS (cont'd)

TND-96

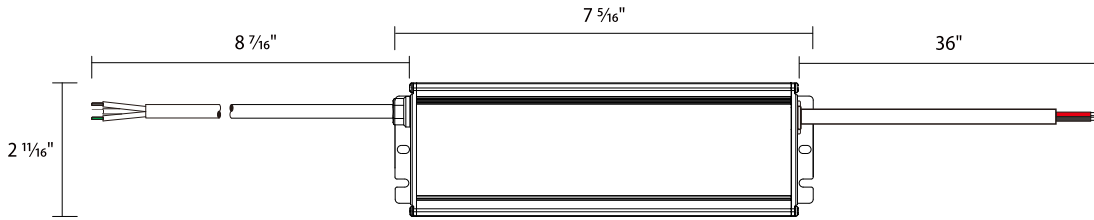

Top-View



Side-View

TND/B

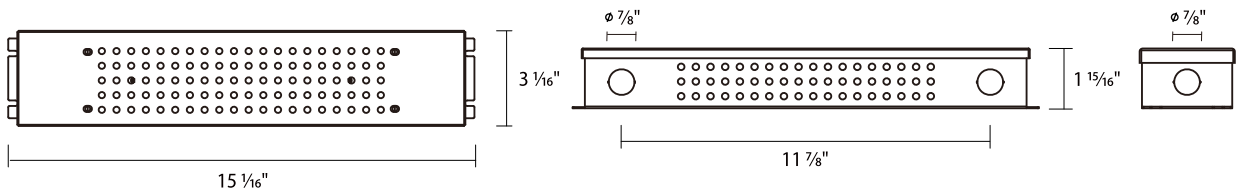

Top-View

Side-View

Side-View

# INSTRUCTIONS

## LED DRIVER INSTALLATION



RAB Lighting is committed to creating high-quality, affordable, well-designed and energy-efficient LED lighting and controls that make it easy for electricians to install and end users to save energy. We'd love to hear your comments. Please call the Marketing Department at 888-RAB-1000 or email: [marketing@rablighting.com](mailto:marketing@rablighting.com)  
**\*\* DON'T TOSS IT—RECYCLE IT! MAKE THE SUSTAINABLE CHOICE BY RECYCLING THIS FIXTURE AT END OF LIFE WITH A LICENSED RECYCLING PROVIDER. \*\***

### WIRING

Option 1: use TID-60 or TID-96 driver with non-dimming.

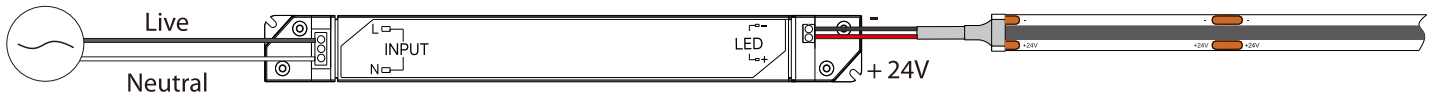

Option 2: use TID-60 or TID-96 driver with TRIAC dimming.

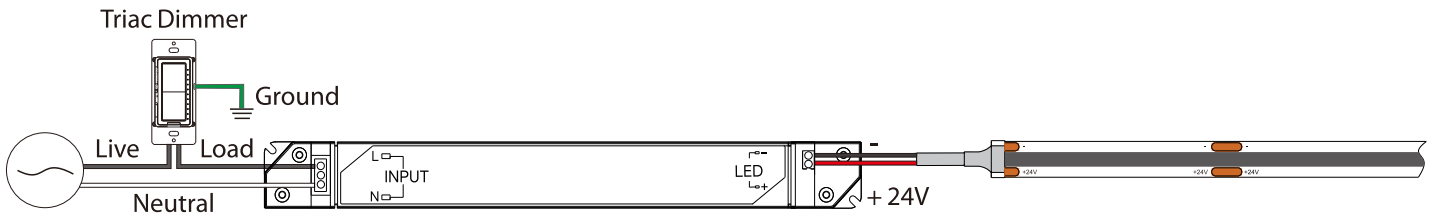

Wire Specification		Value
Input Wire	Gauge	16-20 AWG
Output Wire	Gauge	18-22 AWG

#### Notes:

- This driver is compatible with both leading edge and trailing edge triac dimmer.
- This driver should be installed by qualified and professional person.
- Please make sure the driver is installed in ventilation environment for good heat dissipation.
- For avoiding driver damage, please make sure the electric wiring is correct before testing.

# INSTRUCTIONS

## LED DRIVER INSTALLATION



RAB Lighting is committed to creating high-quality, affordable, well-designed and energy-efficient LED lighting and controls that make it easy for electricians to install and end users to save energy. We'd love to hear your comments. Please call the Marketing Department at 888-RAB-1000 or email: [marketing@rablighting.com](mailto:marketing@rablighting.com)  
**\*\* DON'T TOSS IT—RECYCLE IT! MAKE THE SUSTAINABLE CHOICE BY RECYCLING THIS FIXTURE AT END OF LIFE WITH A LICENSED RECYCLING PROVIDER. \*\***

### WIRING (cont'd)

Option 3: use TOD-96 driver with TRIAC dimming.

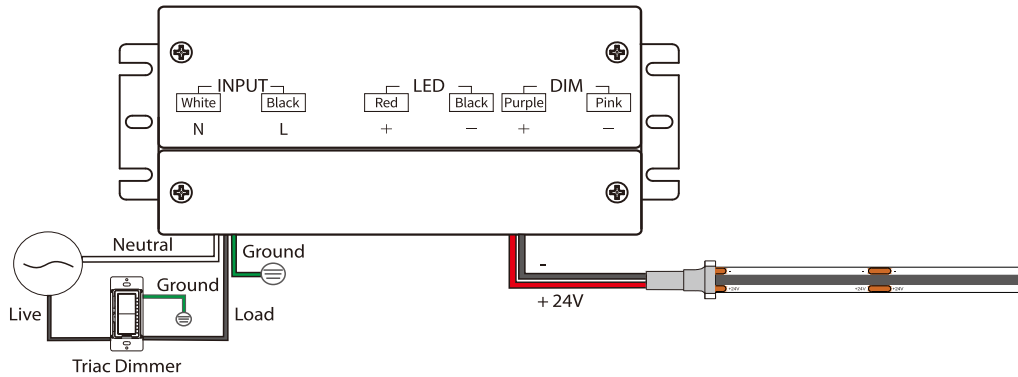

Wire Specification		Value
Input Wire	Gauge	12-18 AWG
Output Wire	Gauge	12-18 AWG

- Notes:**
- This driver is compatible with both leading edge and trailing edge triac dimmer.
  - This driver should be installed by qualified and professional person.
  - Please make sure the driver is installed in ventilation environment for good heat dissipation.
  - For avoiding driver damage, please make sure the electric wiring is correct before testing.
  - Although the waterproof level of the LED driver can reach the wet location in IP65, considering the safety of wiring, it is required that the LED driver should not be directly exposed to outdoor environments that are soaked in rain or water, and should be shielded, such as being placed in a power box.

# INSTRUCTIONS

## LED DRIVER INSTALLATION



RAB Lighting is committed to creating high-quality, affordable, well-designed and energy-efficient LED lighting and controls that make it easy for electricians to install and end users to save energy. We'd love to hear your comments. Please call the Marketing Department at 888-RAB-1000 or email: [marketing@rablighting.com](mailto:marketing@rablighting.com)  
**\*\* DON'T TOSS IT—RECYCLE IT! MAKE THE SUSTAINABLE CHOICE BY RECYCLING THIS FIXTURE AT END OF LIFE WITH A LICENSED RECYCLING PROVIDER. \*\***

### WIRING (cont'd)

Option 4: use TOD-96 driver with 0-10V/1-10V/10V PWM/Potentiometer dimming.

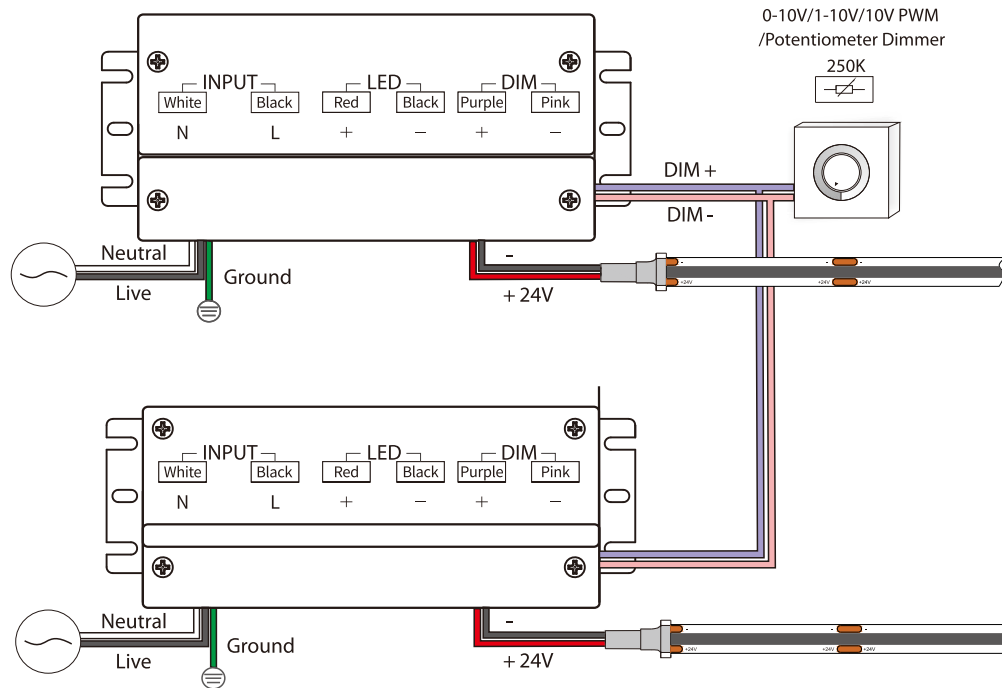

Wire Specification		Value
Input Wire	Gauge	12-18 AWG
Output Wire	Gauge	12-18 AWG

#### Notes:

- Dimming interface characteristics: 0.9V and below are closed, 1V is the darkest, 10V is the brightest, 1-10V is the dimming range.
- The dimming interface distinguishes between positive and negative, DIM+ is positive, DIM- is negative, please do not reverse.
- Dimming interface does not support voltage access higher than 20V, otherwise it will cause damage to the internal components.
- When the dimming interface is open, the driver outputs the maximum current. When the interface is short-circuited, the current output is closed.
- When multiple synchronous dimming is required, the positive poles of the dimming interface of each driver are connected together, and the negative poles are connected together.
- Support passive dimmer or isolated active dimmer dimming, does not support non-isolated active dimmer dimming.
- In general, it is recommended that the number of drivers connected in parallel under the same dimmer does not exceed 30pcs, and the Max. wiring length of dimming wires do not exceed 328ft.
- It is recommended that the dimming wires should not be lower than the 22AWG wire.
- Do not put the dimming wires with high voltage or interference sources. If it is unavoidable, please use the shielded wires.
- Although the waterproof level of the LED driver can reach the wet location in IP65, considering the safety of wiring, it is required that the LED driver should not be directly exposed to outdoor environments that are soaked in rain or water, and should be shielded, such as being placed in a power box.

# INSTRUCTIONS

## LED DRIVER INSTALLATION



RAB Lighting is committed to creating high-quality, affordable, well-designed and energy-efficient LED lighting and controls that make it easy for electricians to install and end users to save energy. We'd love to hear your comments. Please call the Marketing Department at 888-RAB-1000 or email: [marketing@rablighting.com](mailto:marketing@rablighting.com)  
\*\* DON'T TOSS IT—RECYCLE IT! MAKE THE SUSTAINABLE CHOICE BY RECYCLING THIS FIXTURE AT END OF LIFE WITH A LICENSED RECYCLING PROVIDER. \*\*

### WIRING (cont'd)

Option 5: use TND-96 driver with non-dimming.



Wire Specification		Value
Input Wire	Gauge	12-18 AWG
Output Wire	Gauge	12-18 AWG

- Notes:**
- This driver should be installed by qualified and professional person.
  - Please make sure the driver is installed in ventilation environment for good heat dissipation.
  - For avoiding driver damage, please make sure the electric wiring is correct before testing.
  - Although the waterproof level of the LED driver can reach the wet location in IP67, considering the safety of wiring, it is required that the LED driver should not be directly exposed to outdoor environments that are soaked in rain or water, and should be shielded, such as being placed in a power box.

# INSTRUCTIONS

## LED DRIVER INSTALLATION



RAB Lighting is committed to creating high-quality, affordable, well-designed and energy-efficient LED lighting and controls that make it easy for electricians to install and end users to save energy. We'd love to hear your comments. Please call the Marketing Department at 888-RAB-1000 or email: [marketing@rablighting.com](mailto:marketing@rablighting.com)  
\*\* DON'T TOSS IT—RECYCLE IT! MAKE THE SUSTAINABLE CHOICE BY RECYCLING THIS FIXTURE AT END OF LIFE WITH A LICENSED RECYCLING PROVIDER. \*\*

### WIRING (cont'd)

Option6 : TID/B junction box for TID-60 or TID-96 driver, and TND/B junction box for TND-96 driver.

Step 1 - Make sure to turn off the main circuit power supply firstly.

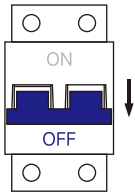

Step 2 - Use a hammer to loosen the knockouts for conduit access then shake it with pliers until broken off.

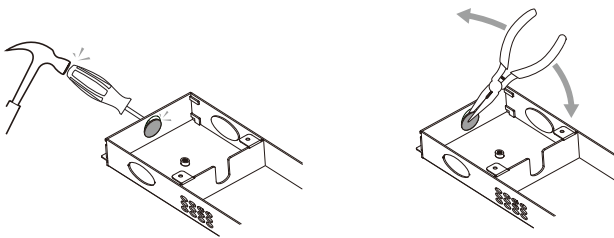

Step 3 - Install the cable strain relief (additional accessories need to be purchased at your local hardware store) into the knockouts and secure it.

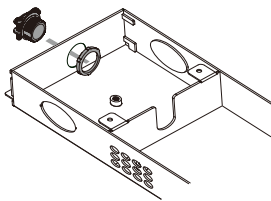

Step 4 - Mount the junction box to a sturdy surface and easy to maintain position, and use driver fitting screws to secure the driver inside the junction box.

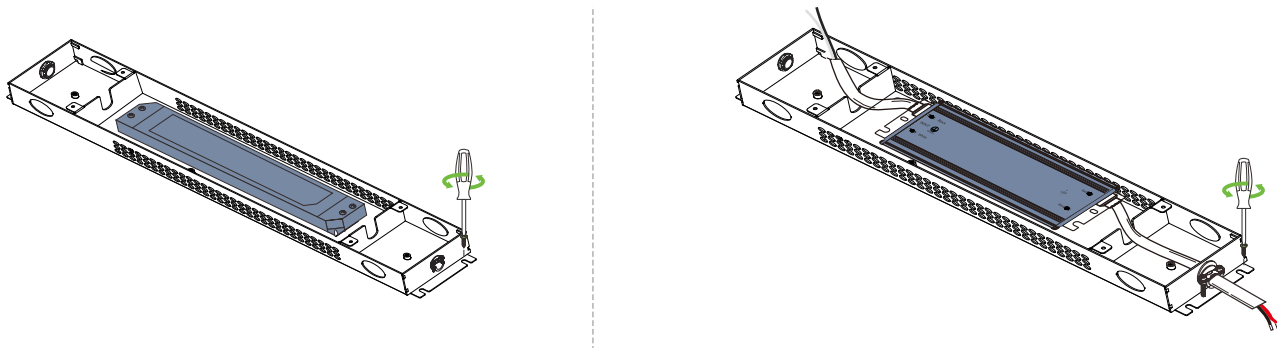

# INSTRUCTIONS

## LED DRIVER INSTALLATION



RAB Lighting is committed to creating high-quality, affordable, well-designed and energy-efficient LED lighting and controls that make it easy for electricians to install and end users to save energy. We'd love to hear your comments. Please call the Marketing Department at 888-RAB-1000 or email: [marketing@rablighting.com](mailto:marketing@rablighting.com)  
\*\* DON'T TOSS IT—RECYCLE IT! MAKE THE SUSTAINABLE CHOICE BY RECYCLING THIS FIXTURE AT END OF LIFE WITH A LICENSED RECYCLING PROVIDER. \*\*

### WIRING (cont'd)

Step 5 - Connect the driver input with the high voltage Ac input power, connect the driver output to low voltage LED load.

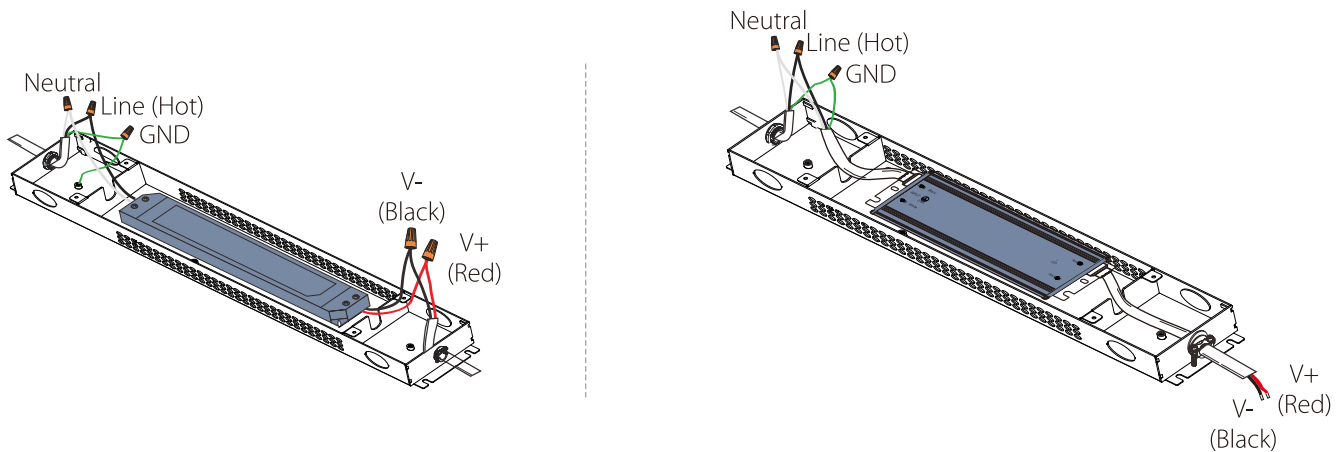

Step 6 - Tighten the cable strain relief by screws, insert the input and output cables into the front and end gap of the junction box, and secure the cover of the junction box.

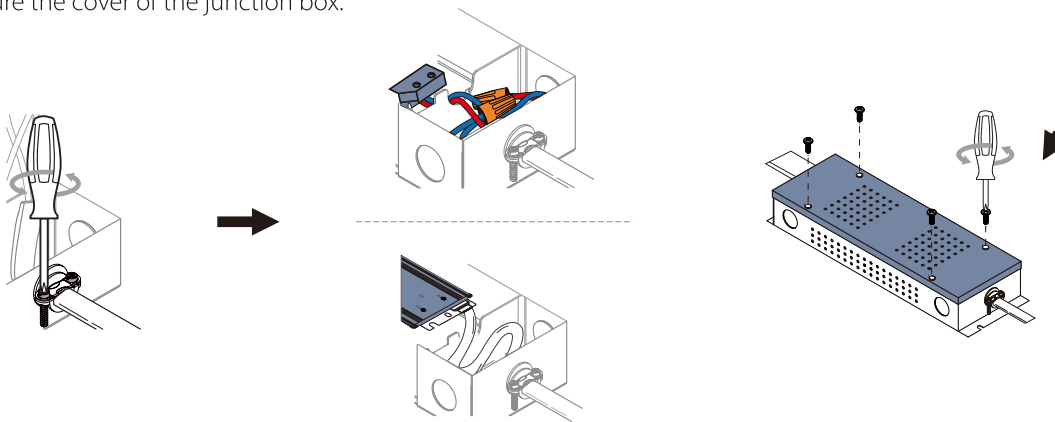

Step 7 - Installation is complete, make sure that the electrical connection is correct first and then switch on the main power supply of the circuit.

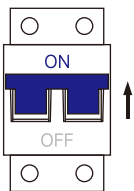

### Notes:

- The necessary tools and accessories are required for installing a junction box, such as screwdrivers, hammers, pliers, cable strain relief, cables, conduit, screws and wiring caps, need to be purchased at a local hardware store.
- If the product fails to work properly after installation, please find a qualified electrician to check the circuit and must disconnect the main power supply before any check.

# INSTRUCTIONS

## LED DRIVER INSTALLATION



RAB Lighting is committed to creating high-quality, affordable, well-designed and energy-efficient LED lighting and controls that make it easy for electricians to install and end users to save energy. We'd love to hear your comments. Please call the Marketing Department at 888-RAB-1000 or email: [marketing@rablighting.com](mailto:marketing@rablighting.com)  
\*\* DON'T TOSS IT—RECYCLE IT! MAKE THE SUSTAINABLE CHOICE BY RECYCLING THIS FIXTURE AT END OF LIFE WITH A LICENSED RECYCLING PROVIDER. \*\*

## SPECIFICATION

Part No.	Input Voltage	Output Power	Output Voltage	Output Current	Power Factor	Certificate	Dimension
TID-60	100-277VAC	60W MAX.	24VDC	2.5A MAX.	>0.95	U.L/cUL/FCC/ Class 2/Class P/RoHS	L11.9 * W1.2 * H0.79 in.
TID-96	100-277VAC	96W MAX.	24VDC	4A MAX.	>0.95	UL/cUL/FCC/ Class 2/Class P/RoHS	L13 * W1.2 * H0.87 in.
TOD-96	100-277VAC	96W MAX.	24VDC	4A MAX.	>0.95	UL/cUL//Class 2/ Class P/TYPE HL/RoHS	L8.7 * W3.8 * H1.6 in.
TND-96	120-277VAC	96W MAX.	24VDC	4A MAX.	>0.95	UL/cUL//Class 2/ Class P/TYPE HL/RoHS	L7.2*W2.7 * H1.5 in.

### Easy Answers

[rablighting.com](http://rablighting.com)  
Visit our website for product info

**Tech Help Line**  
Call our experts: 888 722-1000

**e-mail**  
Answered promptly - [sales@rablighting.com](mailto:sales@rablighting.com)

**Free Lighting Layouts**  
Answered online or by request