

INSTRUCTIONS

TNF TAPE LIGHT INSTALLATION

RAB®

RAB Lighting is committed to creating high-quality, affordable, well-designed and energy-efficient LED lighting and controls that make it easy for electricians to install and end users to save energy. We'd love to hear your comments. Please call the Marketing Department at 888-RAB-1000 or email: marketing@rablighting.com

**** DON'T TOSS IT—RECYCLE IT! MAKE THE SUSTAINABLE CHOICE BY RECYCLING THIS FIXTURE AT END OF LIFE WITH A LICENSED RECYCLING PROVIDER. ****



TNFYY, TNFY, TNFYN, TNFN, TNFCW



TNFLGY



TNF/LCB, TNF/RGB

IMPORTANT

READ CAREFULLY BEFORE INSTALLING FIXTURE. RETAIN THESE INSTRUCTIONS FOR FUTURE REFERENCE.

RAB fixtures must be wired in accordance with the National Electrical Code and all applicable local codes. Proper grounding is required for safety. THIS PRODUCT MUST BE INSTALLED IN ACCORDANCE WITH THE APPLICABLE INSTALLATION CODE BY A PERSON FAMILIAR WITH THE CONSTRUCTION AND OPERATION OF THE PRODUCT AND THE HAZARDS INVOLVED.

1. The operation instruction does not supersede federal, state, local, or (*inter*) national laws, regulations, rules, ordinances, and codes that may apply to electrical installations.
2. The installation and electrical connection process must be operated by a professional electrician using the applicable and appropriate electrical codes.
3. Installation, usage and storage must occur in the environment within the temperature range (*usually -20~45°C for installation & usage and -20~60°C for storage*) indicated on the product datasheet of the neon flex.
4. Make sure the operating voltage of the neon flex coincides with the voltage of the extra LED power supply certified for the LED lighting industry, do not connect the neon flex directly to the AC power such as 120V input.
5. Please choose the suitable waterproof rating of the neon flex according to the actual application scene.
6. Unroll the neon flex from reel before illumination, to avoid product damage caused by the heat.
7. The neon flex can be cut into certain shorter lengths, and also can be spliced into longer lengths. Please refer to the standard length and increment written on the product datasheet of the neon flex. Beyond working length will lead to quality issues like overload, uneven brightness, etc.
8. Turn off the power supply before wiring, assembly, processing, cleaning, maintenance, etc, and ensure all wiring and polarities are correct before powering on.
9. Do not secure the neon flex with staples, nails, or similar objects that can damage the insulated housing for waterproofing.
10. Be aware of ESD protection, handle with care without colliding or crushing, do not mechanically press down on LED and other components, and do not cover the neon flex with heat insulation gasket material.
11. Try to use in a well ventilated environment and avoid complete sealing. Avoid installing and using the neon flex near heat sources, or other potentially dangerous sources like corrosive solvents.
12. To protect your eyes, do not stare at the light for a long time when illuminating the neon flex.
13. An additional heat sink is helpful for the heat conductivity and LED lifetime, please refer to the heat sink and LED lifespan definition on the product datasheet of the neon flex.
14. To reduce the voltage drop as much as possible, the wire length between neon flex and power supply should be as short as possible.
15. Considering the reliability of the LED power supply, it's recommended to use the loading powers not exceed 80% of its rated output power.
16. Make sure that the LED power supply does not generate reverse voltage, it will damage the neon flex.
17. Dust and dirt accumulated over time should be removed from the light emitting surface to assure optimal functioning of the neon flex. Disconnect the power before maintenance and cleaning.
18. Paints, solvents and corrosive cleaning chemicals may not contact and thus affect the neon flex.
19. This product may not be treated as household waste, dispose of the material through the waste recycling of electrical and electronic equipment.
20. CAUTION: The mounting means provided with this neon flex has not been evaluated for reliability. If installed where failure of the mounting means could cause injury to persons or damage to property below, supplemental means of securement should be considered.

INSTRUCTIONS

TNF TAPE LIGHT INSTALLATION

RAB®

RAB Lighting is committed to creating high-quality, affordable, well-designed and energy-efficient LED lighting and controls that make it easy for electricians to install and end users to save energy. We'd love to hear your comments. Please call the Marketing Department at 888-RAB-1000 or email: marketing@rablighting.com
**** DON'T TOSS IT—RECYCLE IT! MAKE THE SUSTAINABLE CHOICE BY RECYCLING THIS FIXTURE AT END OF LIFE WITH A LICENSED RECYCLING PROVIDER. ****

WARNING



SHOCK HAZARD!
IT MAY RESULT IN SERIOUS INJURY OR DEATH!
 Do not connect the neon flex directly to the high voltage power.
 Please turn off the power prior to installation.

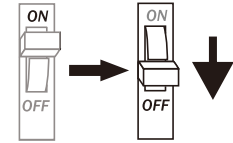

HANDLE PRODUCT WITH CARE!

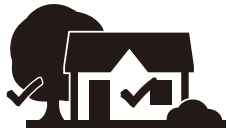

Indoor & outdoor Usage



Do not step on it



Do not pull it



Do not twist It

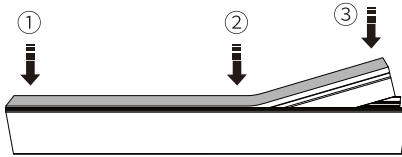

Apply small amounts of force in the same direction, and press downwards or lift upwards in sections.

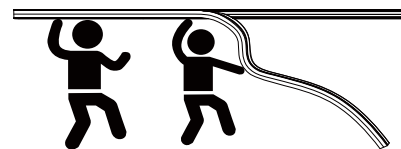

⊕ > 6.56ft. Long ⚠ Operated by 2 people

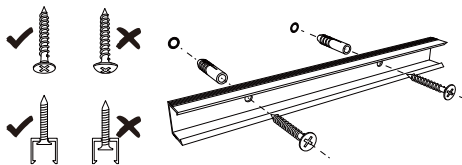

Flat head screws are required.

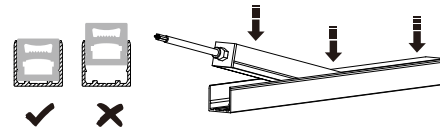

When installing the product onto the accessory, it needs to be pressed to the bottom.

- (1) When installing in environments with significant temperature changes, it is important to consider thermal expansion. Based on the characteristics of the material, the product will have thermal expansion due to temperature changes.
- (2) Try to use tools made of soft and elastic material for installation or disassembly, as dragging or pulling by hand may cause damage to the product.
- (3) Installation or disassembly of products for 6.56ft. or longer requires 2 people to operate, to avoid damage to the product.

BEND & TWIST DIAGRAM



Can be top-bend
 (TNFYY, TNFY, TNFYN, TNFN,
 TNFCW, TNF/LCB, TNF/RGB, TNFLGY)



Can be side-bend
 (TNFYY, TNFY, TNFYN, TNFN,
 TNFCW, TNF/LCB, TNFLGY)

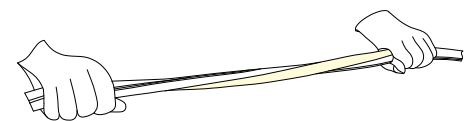
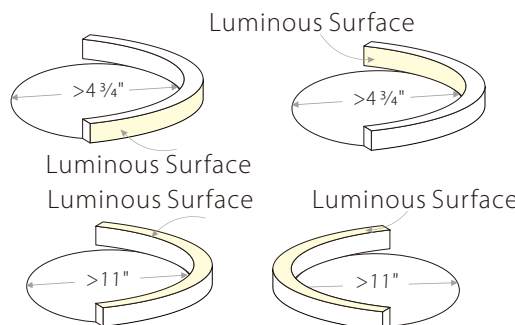

▲ Max. Twist Angle is 360° per 39 3/8".

*TNF/RGB is top-bend only.

INSTRUCTIONS

TNF TAPE LIGHT INSTALLATION



RAB Lighting is committed to creating high-quality, affordable, well-designed and energy-efficient LED lighting and controls that make it easy for electricians to install and end users to save energy. We'd love to hear your comments. Please call the Marketing Department at 888-RAB-1000 or email: marketing@rablighting.com
** DON'T TOSS IT—RECYCLE IT! MAKE THE SUSTAINABLE CHOICE BY RECYCLING THIS FIXTURE AT END OF LIFE WITH A LICENSED RECYCLING PROVIDER. **

INSTALLATION

Option 1.1: Fixed by bracket and screw in TB16 (*TNFYY, TNFY, TNFYN, TNFN, TNFCW, TNF/LCB, TNF/RGB*).

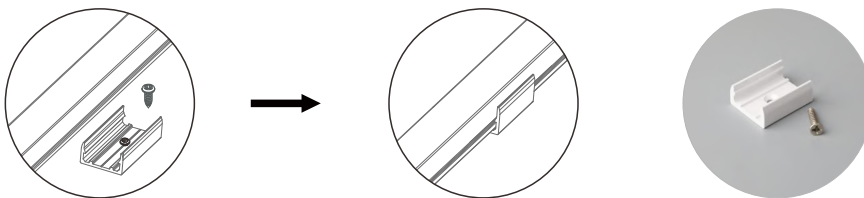

Space & Groove are shown as below

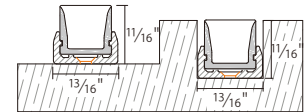

Surface & Recessed mounting

Note: White color is standard. PC material is not recommended for long-term exposure to outdoor sunlight.

Option 1.2: Fixed by bracket and screw in TB16B (*TNFLGY*).

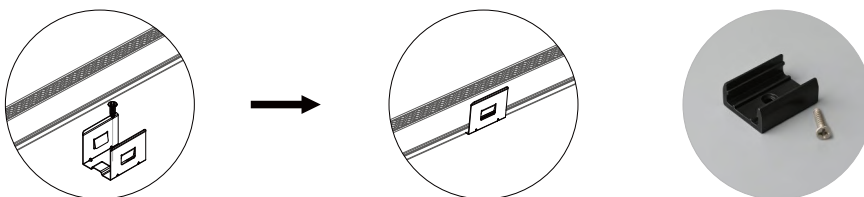

Space & Groove are shown as below

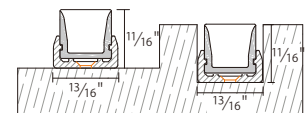

Surface & Recessed mounting

Note: Black color is standard. PC material is not recommended for long-term exposure to outdoor sunlight.

Option 2: Fixed by aluminum profile and screw in TAP16 (*TNFYY, TNFY, TNFYN, TNFN, TNFCW, TNF/LCB, TNF/RGB, TNFLGY*).

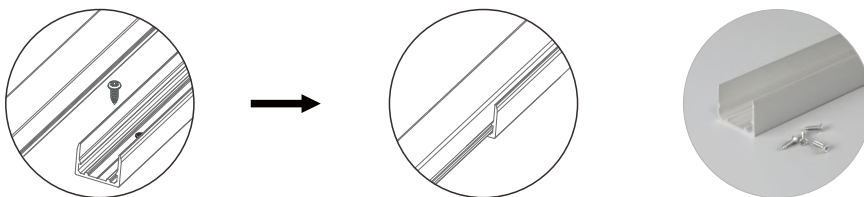

Space & Groove are shown as below

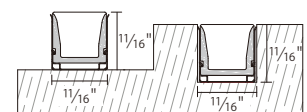

Surface & Recessed mounting

Note: Silver color is standard.

Option 3: Fixed by bendable bracket and screw in TBB16 (*TNFYY, TNFY, TNFYN, TNFN, TNFCW, TNF/LCB, TNFLGY*).

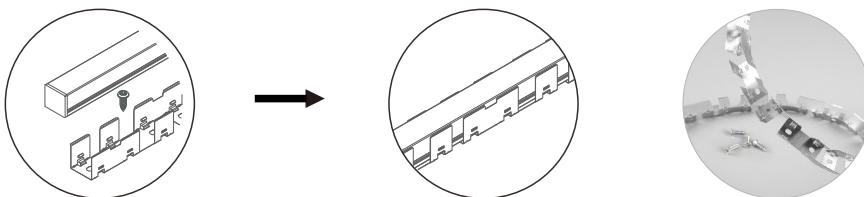

Space & Groove are shown as below

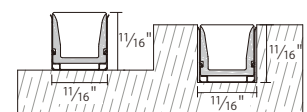

Surface & Recessed mounting

Note: Silver color is standard.

INSTRUCTIONS

TNF TAPE LIGHT INSTALLATION



RAB Lighting is committed to creating high-quality, affordable, well-designed and energy-efficient LED lighting and controls that make it easy for electricians to install and end users to save energy. We'd love to hear your comments. Please call the Marketing Department at 888-RAB-1000 or email: marketing@rablighting.com
** DON'T TOSS IT—RECYCLE IT! MAKE THE SUSTAINABLE CHOICE BY RECYCLING THIS FIXTURE AT END OF LIFE WITH A LICENSED RECYCLING PROVIDER. **

INSTALLATION (cont'd)

Option 4: Fixed by plaster-in aluminum profile and screw in TAP16TL (*TNFYY, TNFY, TNFYN, TNFN, TNFCW, TNF/LCB, TNF/RGB, TNFLGY*).

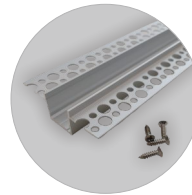
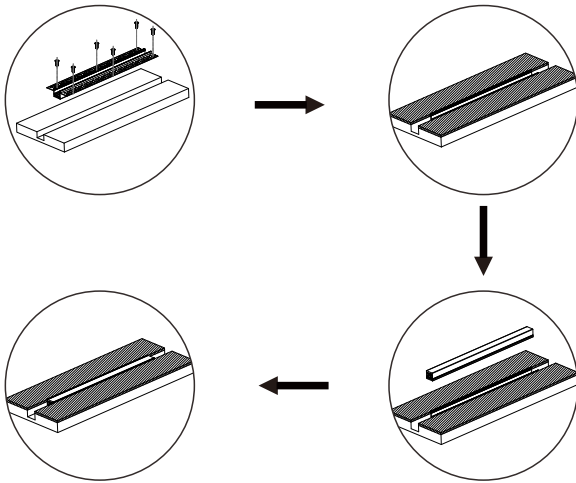

Space & Groove are shown as below
Depth of the plastering layer

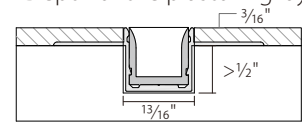

Recessed mounting

Note: Silver color is standard.

INSTRUCTIONS

TNF TAPE LIGHT INSTALLATION



RAB Lighting is committed to creating high-quality, affordable, well-designed and energy-efficient LED lighting and controls that make it easy for electricians to install and end users to save energy. We'd love to hear your comments. Please call the Marketing Department at 888-RAB-1000 or email: marketing@rablighting.com
**** DON'T TOSS IT—RECYCLE IT! MAKE THE SUSTAINABLE CHOICE BY RECYCLING THIS FIXTURE AT END OF LIFE WITH A LICENSED RECYCLING PROVIDER. ****

WIRING for TNFY

Power entry from the tail

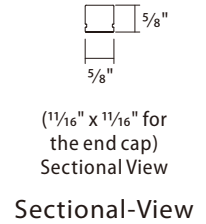
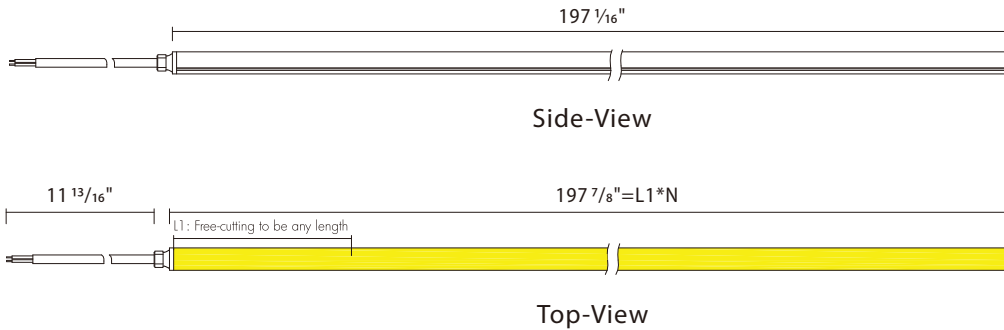

Power entry from the side

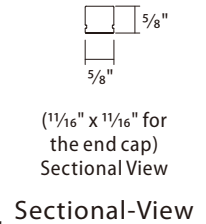
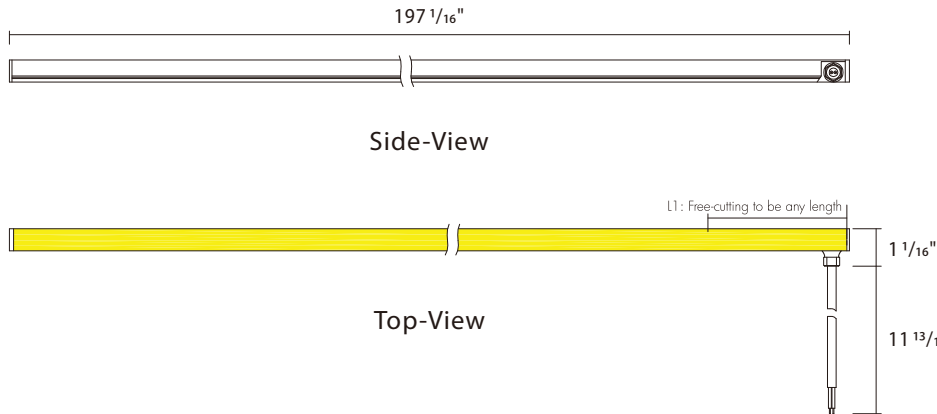

Power Entry from the bottom

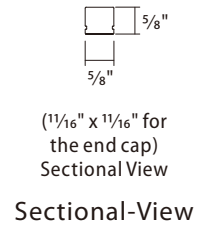
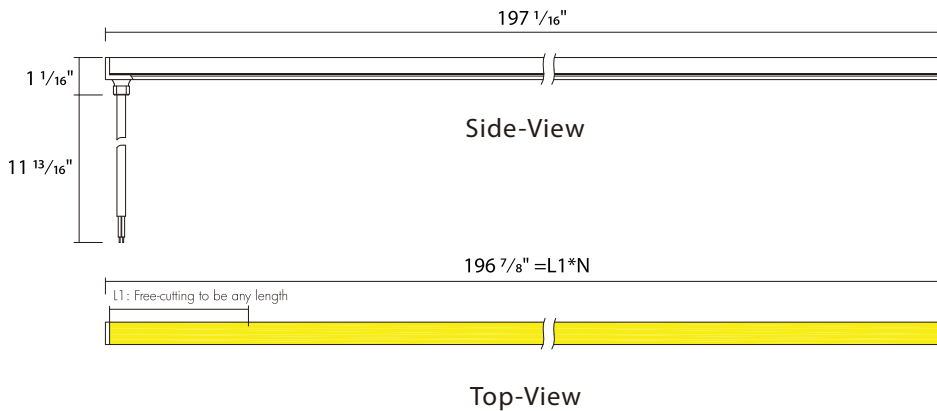

INSTRUCTIONS

TNF TAPE LIGHT INSTALLATION



RAB Lighting is committed to creating high-quality, affordable, well-designed and energy-efficient LED lighting and controls that make it easy for electricians to install and end users to save energy. We'd love to hear your comments. Please call the Marketing Department at 888-RAB-1000 or email: marketing@rablighting.com
** DON'T TOSS IT—RECYCLE IT! MAKE THE SUSTAINABLE CHOICE BY RECYCLING THIS FIXTURE AT END OF LIFE WITH A LICENSED RECYCLING PROVIDER. **

WIRING for TNFY, TNFY, TNFY, TNFN, TNFCW, TNFLGY

Option 1: use TID-60 or TID-96 driver with TRIAC dimming for indoor application.

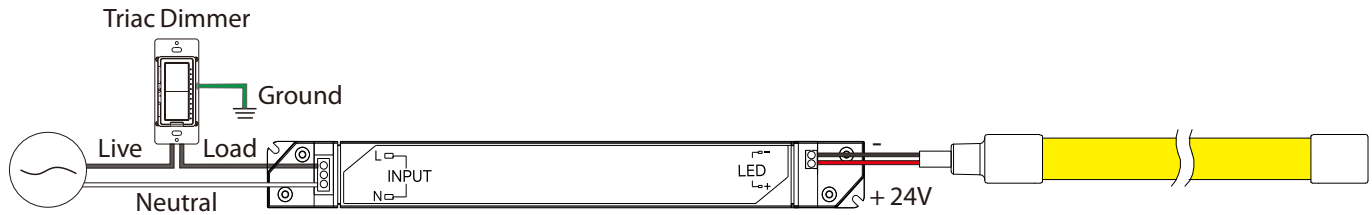

Wire Specification		Value
Input Wire	Gauge	16-20 AWG
Output Wire	Gauge	18-22 AWG

Notes:

- This driver is compatible with both leading edge and trailing edge triac dimmer.
- This driver should be installed by qualified and professional person.
- Please make sure the driver is installed in ventilation environment for good heat dissipation.
- For avoiding driver damage, please make sure the electric wiring is correct before testing.

INSTRUCTIONS

TNF TAPE LIGHT INSTALLATION



RAB Lighting is committed to creating high-quality, affordable, well-designed and energy-efficient LED lighting and controls that make it easy for electricians to install and end users to save energy. We'd love to hear your comments. Please call the Marketing Department at 888-RAB-1000 or email: marketing@rablighting.com

** DON'T TOSS IT—RECYCLE IT! MAKE THE SUSTAINABLE CHOICE BY RECYCLING THIS FIXTURE AT END OF LIFE WITH A LICENSED RECYCLING PROVIDER. **

WIRING for TNFYY, TNFY, TNFYN, TNFN, TNFCW, TNFLGY

Option 2: use TOD-96 driver with TRIAC dimming for white neon flex light.

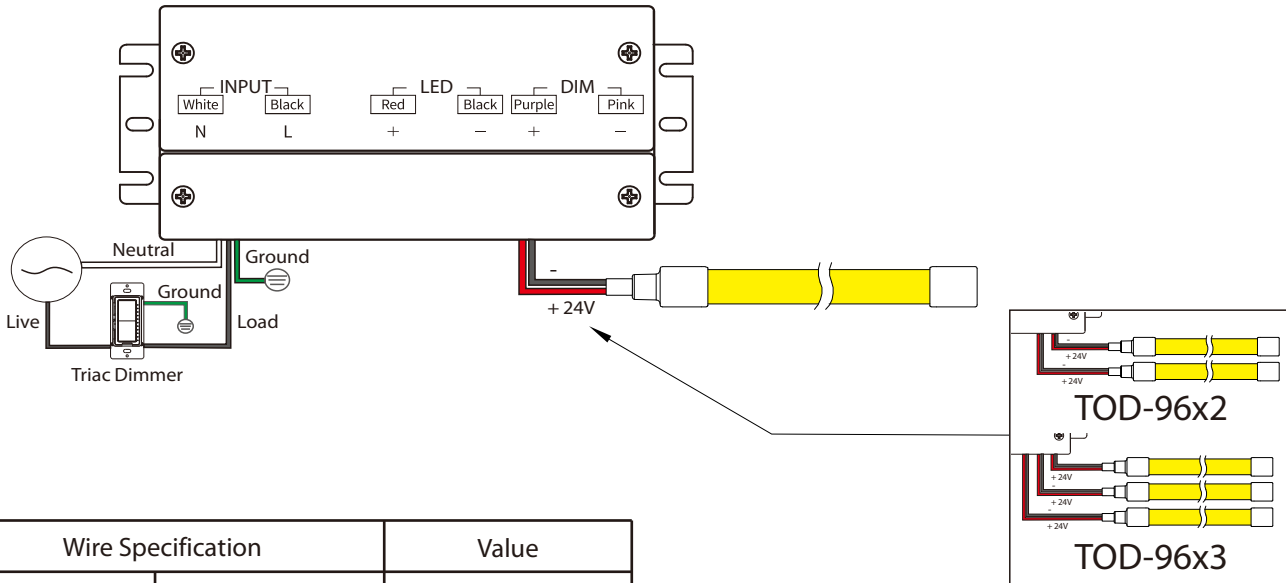

Wire Specification		Value
Input Wire	Gauge	12-18 AWG
Output Wire	Gauge	12-18 AWG

- Notes:**
- This driver is compatible with both leading edge and trailing edge triac dimmer.
 - This driver should be installed by qualified and professional person.
 - Please make sure the driver is installed in ventilation environment for good heat dissipation.
 - For avoiding driver damage, please make sure the electric wiring is correct before testing.
 - Although the waterproof level of the LED driver can reach the wet location in IP65, considering the safety of wiring, it is required that the LED driver should not be directly exposed to outdoor environments that are soaked in rain or water, and should be shielded, such as being placed in a power box.

INSTRUCTIONS

TNF TAPE LIGHT INSTALLATION



RAB Lighting is committed to creating high-quality, affordable, well-designed and energy-efficient LED lighting and controls that make it easy for electricians to install and end users to save energy. We'd love to hear your comments. Please call the Marketing Department at 888-RAB-1000 or email: marketing@rablighting.com
**** DON'T TOSS IT—RECYCLE IT! MAKE THE SUSTAINABLE CHOICE BY RECYCLING THIS FIXTURE AT END OF LIFE WITH A LICENSED RECYCLING PROVIDER. ****

WIRING for TNFY, TNFY, TNFY, TNFN, TNFCW, TNFLGY

Option 3: use TOD-96 driver with 0-10V/1-10V/10V PWM/Potentiometer dimming for white neon flex light.

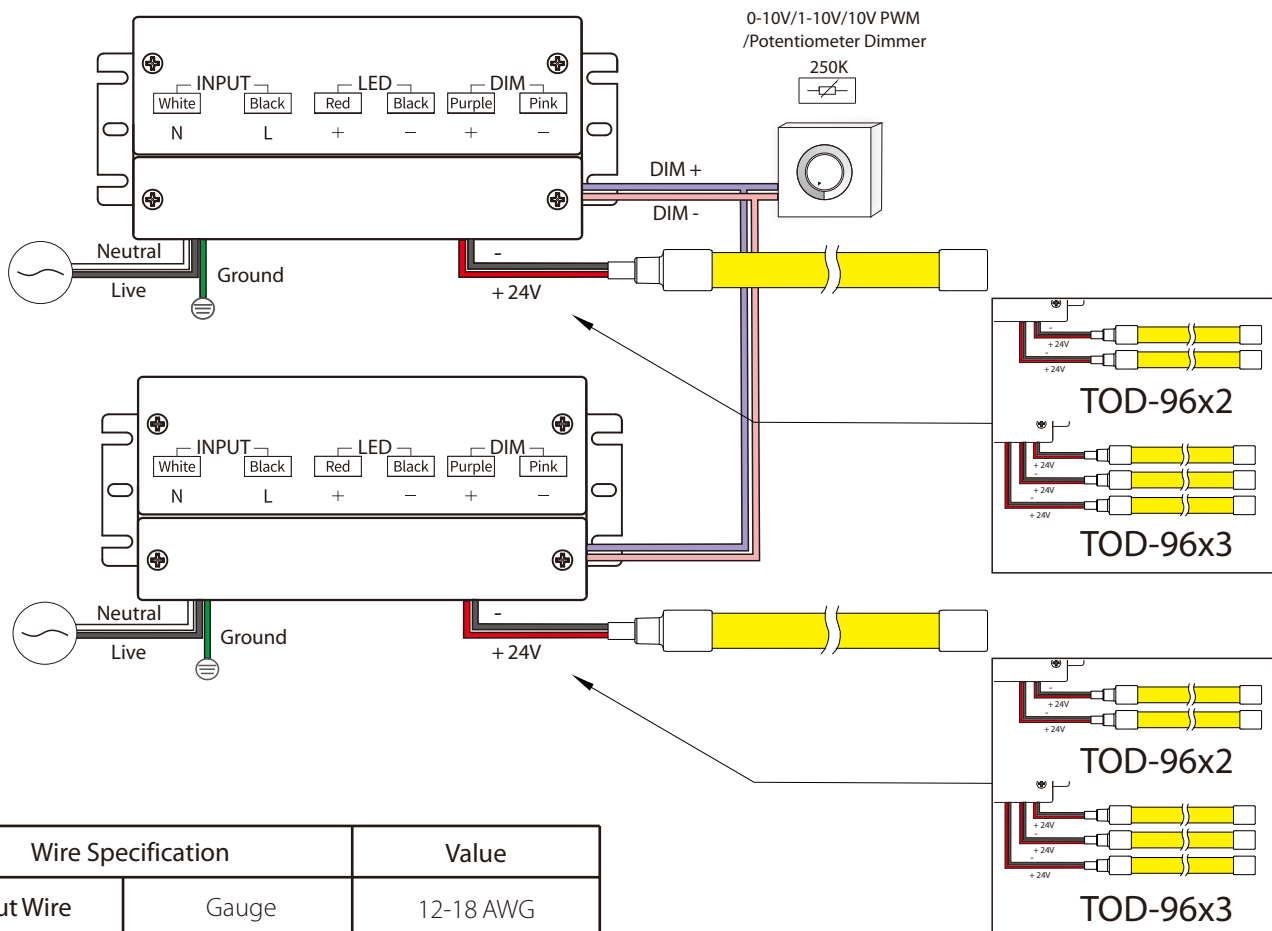

Wire Specification		Value
Input Wire	Gauge	12-18 AWG
Output Wire	Gauge	12-18 AWG

Notes:

- Dimming interface characteristics: 0.9V and below are closed, 1V is the darkest, 10V is the brightest, 1-10V is the dimming range.
- The dimming interface distinguishes between positive and negative, DIM+ is positive, DIM- is negative, please do not reverse.
- Dimming interface does not support voltage access higher than 20V, otherwise it will cause damage to the internal components.
- When the dimming interface is open, the driver outputs the maximum current. When the interface is short-circuited, the current output is closed.
- When multiple synchronous dimming is required, the positive poles of the dimming interface of each driver are connected together, and the negative poles are connected together.
- Support passive dimmer or isolated active dimmer dimming, does not support non-isolated active dimmer dimming.
- In general, it is recommended that the number of drivers connected in parallel under the same dimmer does not exceed 30pcs, and the Max. wiring length of dimming wires do not exceed 328ft.
- It is recommended that the dimming wires should not be lower than the 22AWG wire.
- Do not put the dimming wires with high voltage or interference sources. If it is unavoidable, please use the shielded wires.
- Although the waterproof level of the LED driver can reach the wet location in IP65, considering the safety of wiring, it is required that the LED driver should not be directly exposed to outdoor environments that are soaked in rain or water, and should be shielded, such as being placed in a power box.

INSTRUCTIONS

TNF TAPE LIGHT INSTALLATION



RAB Lighting is committed to creating high-quality, affordable, well-designed and energy-efficient LED lighting and controls that make it easy for electricians to install and end users to save energy. We'd love to hear your comments. Please call the Marketing Department at 888-RAB-1000 or email: marketing@rablighting.com
**** DON'T TOSS IT—RECYCLE IT! MAKE THE SUSTAINABLE CHOICE BY RECYCLING THIS FIXTURE AT END OF LIFE WITH A LICENSED RECYCLING PROVIDER. ****

WIRING for TNF/LCB, TNF/RGB

Power entry from the bottom

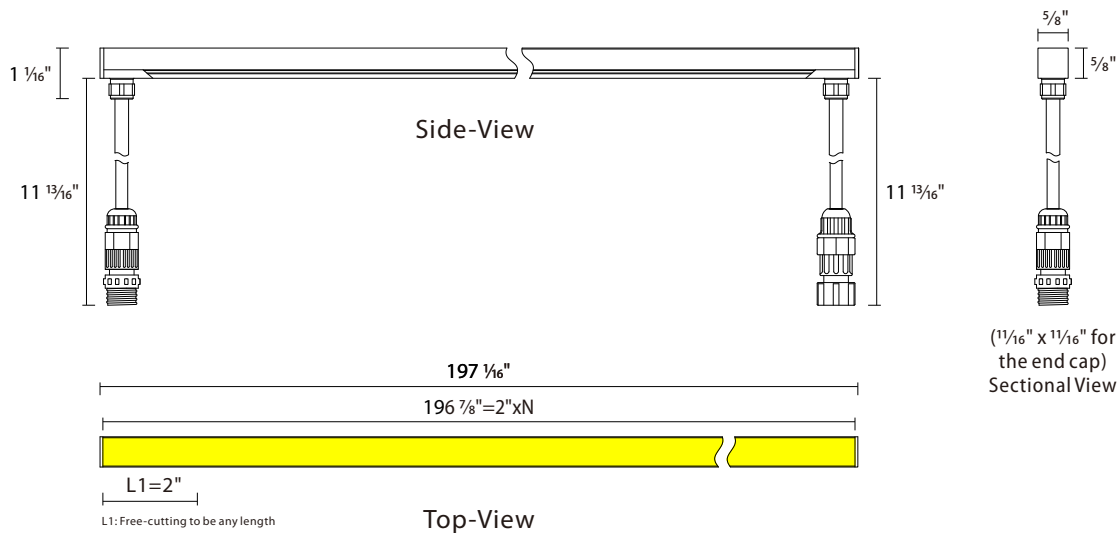

Power entry from the side

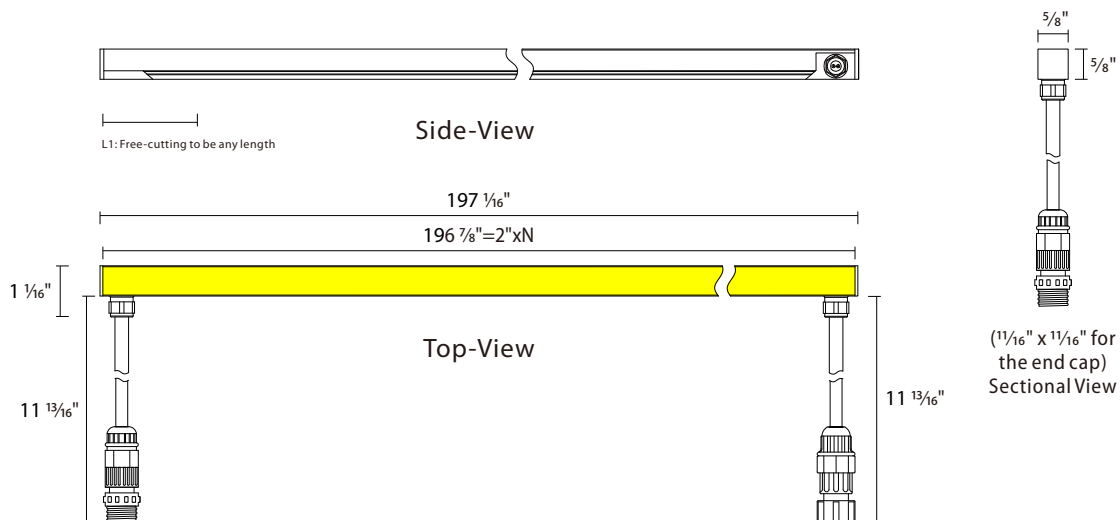

Note:

- (1) TNF/LCB 3-pin male/female M12 connector with color in black (+) / yellow (w) / white (c).
- (2) TNF/RGB 5-pin male/female M12 connector with color in black (+) / Green (PI/PO) / red (A) / blue (B) / white (GND).

INSTRUCTIONS

TNF TAPE LIGHT INSTALLATION



RAB Lighting is committed to creating high-quality, affordable, well-designed and energy-efficient LED lighting and controls that make it easy for electricians to install and end users to save energy. We'd love to hear your comments. Please call the Marketing Department at 888-RAB-1000 or email: marketing@rablighting.com
 ** DON'T TOSS IT—RECYCLE IT! MAKE THE SUSTAINABLE CHOICE BY RECYCLING THIS FIXTURE AT END OF LIFE WITH A LICENSED RECYCLING PROVIDER. **

WIRING for TNF/LCB, TNF/RGB

TNF/LCB Uses driver TND-96 and controller LCBLV/TW.

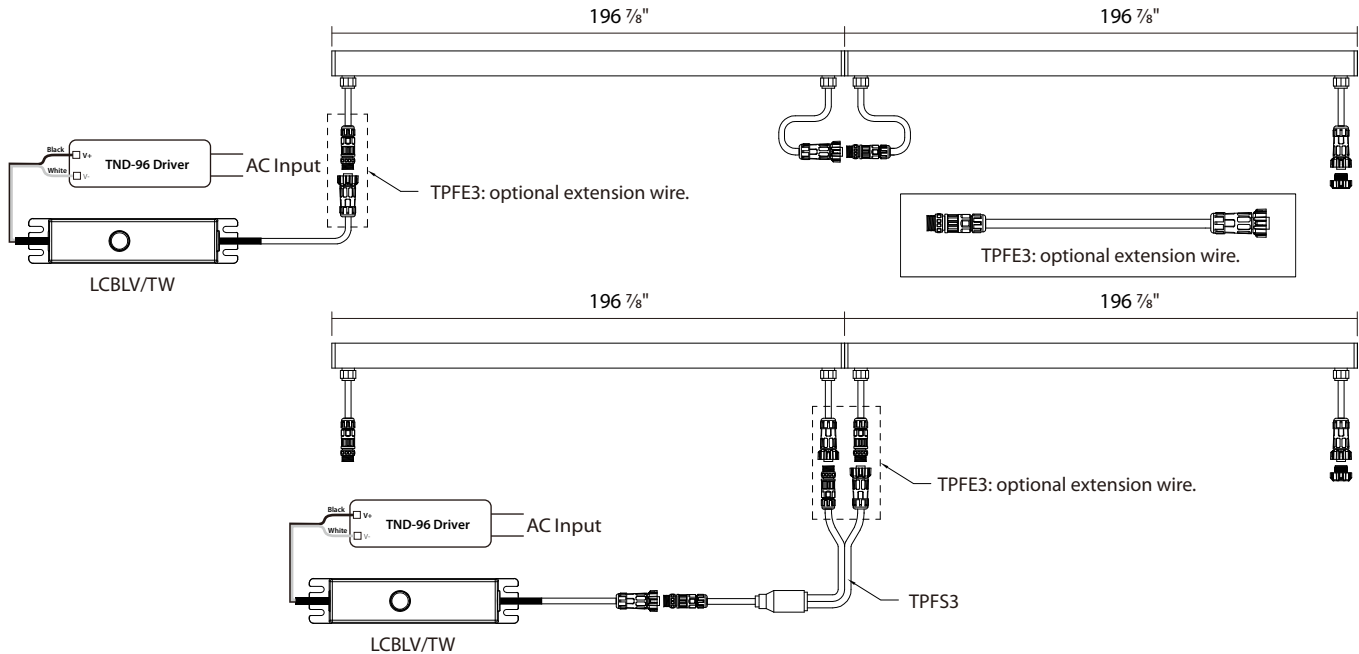

TNF/RGB Uses driver TND-96 and controller LCBLVD/RGB.

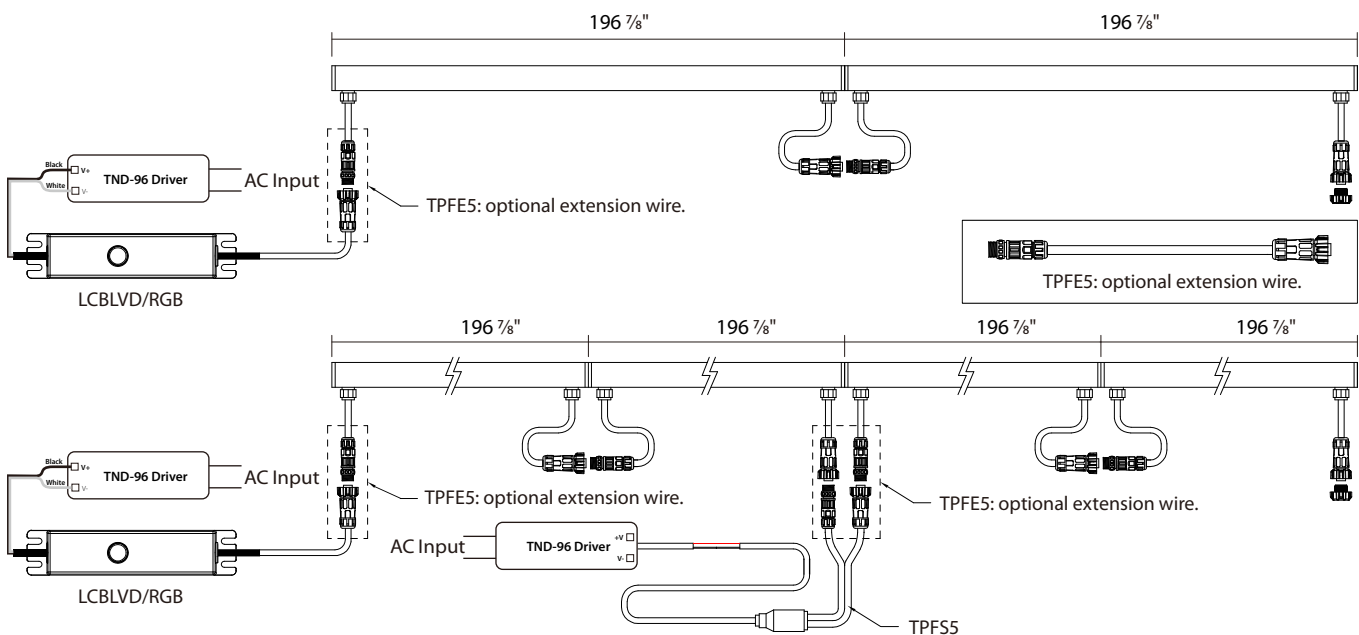

Notes:

- This driver and DMX controller should be installed by qualified and professional person.
- Please make sure the driver and DMX controller are installed in ventilation environment for good heat dissipation.
- For avoiding driver damage, please make sure the electric wiring is correct before testing.
- Although the waterproof level of the LED driver can reach the wet location in IP67, considering the safety of wiring, it is required that the LED driver and DMX controller should not be directly exposed to outdoor environments that are soaked in rain or water, and should be shielded, such as being placed in a power box.

INSTRUCTIONS

TNF TAPE LIGHT INSTALLATION

RAB®

RAB Lighting is committed to creating high-quality, affordable, well-designed and energy-efficient LED lighting and controls that make it easy for electricians to install and end users to save energy. We'd love to hear your comments. Please call the Marketing Department at 888-RAB-1000 or email: marketing@rablighting.com
** DON'T TOSS IT—RECYCLE IT! MAKE THE SUSTAINABLE CHOICE BY RECYCLING THIS FIXTURE AT END OF LIFE WITH A LICENSED RECYCLING PROVIDER. **

ASSEMBLY

Option 1: apply the wire soldering process in TPF2NF, TPF3NF, TPF5NF.

(1) Cut the product along the laser cutting line according to the required length.

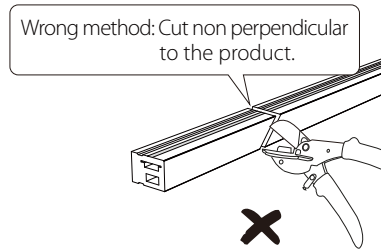
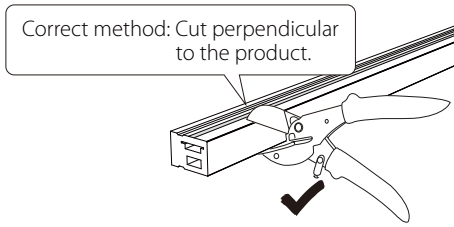

(2) Peel off the jacket on the back of the PCBA to expose the solder pads.

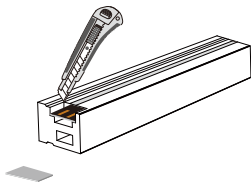

(3) Solder the cables to the corresponding polarity on the solder pads.

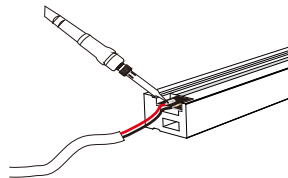

(4) Thread the cable through the front end cap and fill it with 1/3~1/2 capacity glue.

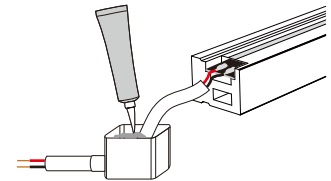

(5) Push the end cap onto the product, and lay it flat to dry for 2 hours.

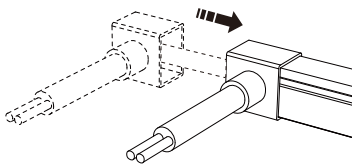

(6) Fill the tail end cap with 1/3~1/2 capacity glue, push it onto the product, and lay it flat to dry for 2 hours.

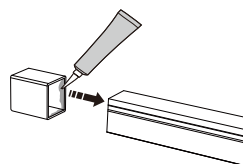

RAB®
© 2025 RAB LIGHTING Inc.
Cranbury, New Jersey 08512 USA

Easy Answers

rablighting.com
Visit our website for product info

Tech Help Line
Call our experts: 888 722-1000

e-mail
Answered promptly - sales@rablighting.com

Free Lighting Layouts
Answered online or by request

NEONFLEX-IN-0525
P-101646

RAB WARRANTY: RAB's warranty is subject to all terms and conditions found at rablighting.com/warranty.

INSTRUCTIONS

TNF TAPE LIGHT INSTALLATION



RAB Lighting is committed to creating high-quality, affordable, well-designed and energy-efficient LED lighting and controls that make it easy for electricians to install and end users to save energy. We'd love to hear your comments. Please call the Marketing Department at 888-RAB-1000 or email: marketing@rablighting.com
**** DON'T TOSS IT—RECYCLE IT! MAKE THE SUSTAINABLE CHOICE BY RECYCLING THIS FIXTURE AT END OF LIFE WITH A LICENSED RECYCLING PROVIDER. ****

Accessory Compatibility List

Tape Light Family	Acc CAT Nos	Acc Description
TNFYY, TNFY, TNFYN, TNFN, TNFCW	TPF2NF	2pin Power feed kit for W16*H16mm Neon
	TSG	Silicon glue 10ml per unit, for TPF or TOJ or TOCJ
	TB16	16mm wide mounting brackets
	TBB16	16mm wide bendable mounting brackets (for TNF/LCB only)
	TAP16	16mm wide aluminum channel
	TAP16TL	Trimless 16mm inner wide recessed aluminum profile
	TID-60	60W indoor driver (for indoor only)
	TID-96	96W indoor driver (for indoor only)
	TID/B	J-box for TID Drivers
	TOD-96	96W outdoor LED driver 5in1 dimming
	TOD-96x2	96Wx2 outdoor LED driver 5in1 dimming
	TOD-96x3	96Wx3 outdoor LED driver 5in1 dimming
TNFLGY	TPF2NFB	2pin Power feed kit for W16*H16mm Black Neon
	TSG	Silicon glue 10ml per unit, for TPF or TOJ or TOCJ
	TB16B	16mm wide mounting brackets for W16*H16mm Black Neon
	TAP16	16mm wide aluminum channel (Aluminum color)
	TAP16TL	Trimless 16mm inner wide recessed aluminum profile (Aluminum color)
	TID-60	60W indoor driver (for indoor only)
	TID-96	96W indoor driver (for indoor only)
	TID/B	J-box for TID Drivers
	TOD-96	96W outdoor LED driver 5in1 dimming
	TOD-96x2	96Wx2 outdoor LED driver 5in1 dimming
	TOD-96x3	96Wx3 outdoor LED driver 5in1 dimming
	TNF/LCB	TPF3NF
TPFE3		3pin Power Extender with M12 Connector L=8FT for 3pin Tape Light
TPFS3		3pin Wire Splitter with M12 Connector L=1.5FT for 3pin Tape Light
TSG		Silicon glue 10ml per unit, for TPF or TOJ or TOCJ
TB16		16mm wide mounting brackets
TBB16		16mm wide bendable mounting brackets (for TNF/LCB only)
TAP16		16mm wide aluminum channel
TAP16TL		Trimless 16mm inner wide recessed aluminum profile
TND-96		96W outdoor ON/OFF LED driver
TND/B		J-box for TND Drivers

INSTRUCTIONS

TNF TAPE LIGHT INSTALLATION



RAB Lighting is committed to creating high-quality, affordable, well-designed and energy-efficient LED lighting and controls that make it easy for electricians to install and end users to save energy. We'd love to hear your comments. Please call the Marketing Department at 888-RAB-1000 or email: marketing@rablighting.com
**** DON'T TOSS IT—RECYCLE IT! MAKE THE SUSTAINABLE CHOICE BY RECYCLING THIS FIXTURE AT END OF LIFE WITH A LICENSED RECYCLING PROVIDER. ****

Accessory Compatibility List

Tape Light Family	Acc CAT Nos	Acc Description
TNF/RGB	TPF5NF	5pin Power feed kit with M12 Connector L=1FT for Neon Flex DMX RGBW
	TPFE5	5pin Power Extender with M12 Connector L=8FT for 5pin Tape Light with white Connector
	TPFS5	5pin Wire Splitter with M12 Connector L=1.5FT for 5pin Tape Light
	TSG	Silicon glue 10ml per unit, for TPF or TOJ or TOCJ
	TB16	16mm wide mounting brackets
	TAP16	16mm wide aluminum channel
	TAP16TL	Trimless 16mm inner wide recessed aluminum profile
	TND-96	96W outdoor ON/OFF LED driver
	TND/B	J-box for TND Drivers