

# INSTRUCTIONS

## X17™ XFU 3-WAY FIELD-ADJUSTABLE FLOODLIGHT SELECTABLE PHOTOCELL INSTALLATION



RAB Lighting is committed to creating high-quality, affordable, well-designed and energy-efficient LED lighting and controls that make it easy for electricians to install and end users to save energy. We'd love to hear your comments. Please call the Marketing Department at 888-RAB-1000 or email: marketing@rablighting.com



X17 XFU 35/25/15W Knuckle

### IMPORTANT

#### **READ CAREFULLY BEFORE INSTALLING FIXTURE. RETAIN THESE INSTRUCTIONS FOR FUTURE REFERENCE.**

RAB fixtures must be wired in accordance with the National Electrical Code and all applicable local codes. Proper grounding is required for safety. THIS PRODUCT MUST BE INSTALLED IN ACCORDANCE WITH THE APPLICABLE INSTALLATION CODE BY A PERSON FAMILIAR WITH THE CONSTRUCTION AND OPERATION OF THE PRODUCT AND THE HAZARDS INVOLVED.

**WARNING: Make certain power is OFF before installing or maintaining fixture. No user serviceable parts inside.**

**WARNING: Do not use an electric generator to test LED fixtures.**

**WARNING: Min 75°C SUPPLY CONDUCTORS.**

### KNUCKLE MOUNT

To ensure weatherproof seal, apply weatherproof silicone sealant around the edge of the junction box (*not supplied*). This is especially important with an uneven wall surface.

1. Secure the fixture to a 1/2" NPS hole in the junction box or landscape post as shown in **Fig. 1**. Seal arm thread using Teflon® tape or silicone sealant.
2. Make appropriate wire connections per NEC in an approved enclosure (*not included*) see **Fig. 5**.
3. The **Knuckle Arm** allows 180° of vertical aiming adjustment depending on the mounting position as shown in **Fig. 2**.

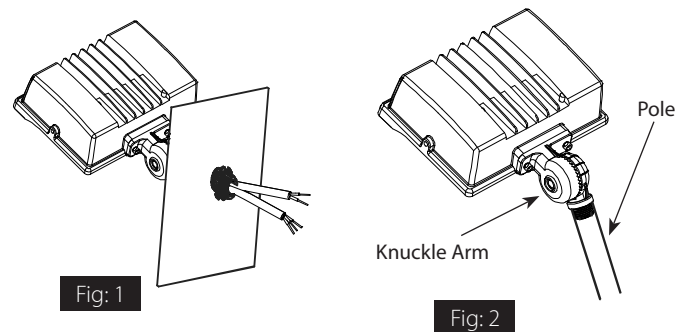

### FIELD ADJUSTMENT

Follow instructions below to change fixture **Power (W)** or **Color Temperature (CCT)** from the factory settings and **Photocell On/Off** option.

#### **Factory Settings: 4000K and 35W**

1. Remove **Selector Switch Caps** by turning counterclockwise using a flat head screwdriver (*Fig. 3*).
2. Locate the **Selector Switches** on the fixture (*Fig. 4*).
3. Select **Power (W)** and **Color Temperature (CCT)** by sliding the respective switch to the desired value.
4. Select **Photocell On/Off** option by sliding respective switch to the desired value.

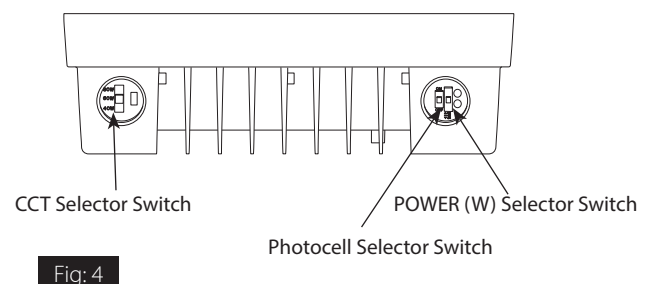
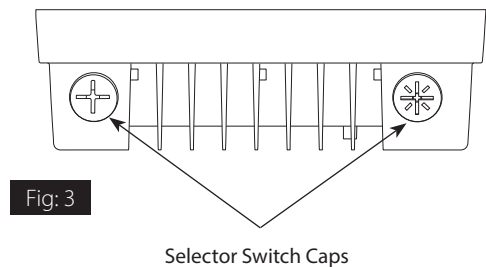

# INSTRUCTIONS

## X17™ XFU 3-WAY FIELD-ADJUSTABLE FLOODLIGHT SELECTABLE PHOTOCELL INSTALLATION



RAB Lighting is committed to creating high-quality, affordable, well-designed and energy-efficient LED lighting and controls that make it easy for electricians to install and end users to save energy. We'd love to hear your comments. Please call the Marketing Department at 888-RAB-1000 or email: [marketing@rablighting.com](mailto:marketing@rablighting.com)

### 0-10V DIMMABLE WIRING

Universal voltage driver permits operation at 120V thru 277V, 50 or 60 Hz. For 0-10 Dimming, follow the wiring directions as in **Fig. 5**.

1. Connect the Black/Brown fixture lead to the LINE supply lead.
2. Connect the White/Blue fixture lead to the COMMON supply lead.
3. Connect the Green/Yellow wire from fixture to supply ground. Do NOT connect the GROUND of the dimming fixture to the output.
4. Connect the purple fixture lead to the DIM V+ lead.
5. Connect the gray fixture lead to the DIM V- lead.
6. Cap the yellow fixture lead, if present. Do NOT connect.

### CLEANING & MAINTENANCE

**CAUTION: Be sure fixture temperature is cool enough to touch. Do not clean or maintain while fixture is energized.**

1. Clean glass lens with non-abrasive glass cleaning solution.
2. Do not open the fixture to clean the LED. Do not touch the LED.

### TROUBLESHOOTING

1. Is the fixture grounded properly?
2. It is recommended that gloves be worn to avoid injury during installation.
3. If any smoke or spark, please turn off the power immediately.

Fig: 5

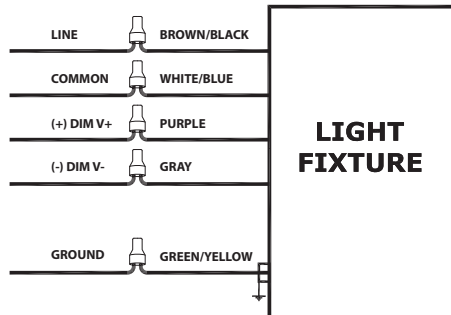

*Note: These instructions do not cover all details or variations in equipment nor do they provide for every possible situation during installation, operation or maintenance.*



© 2021 RAB LIGHTING Inc.  
X17 XFU 35-25-15 IN-0921  
73729-RAB

#### Easy Answers

[rablighting.com](http://rablighting.com)  
Visit our website for product info

Tech Help Line  
Call our experts: 888 722-1000

e-mail  
Answered promptly - [sales@rablighting.com](mailto:sales@rablighting.com)

Free Lighting Layouts  
Answered online or by request

# INSTRUCTIONS

## X17™ XFU 3-WAY FIELD-ADJUSTABLE FLOODLIGHT INSTALLATION



RAB Lighting is committed to creating high-quality, affordable, well-designed and energy-efficient LED lighting and controls that make it easy for electricians to install and end users to save energy. We'd love to hear your comments. Please call the Marketing Department at 888-RAB-1000 or email: marketing@rablighting.com

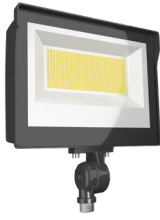

X17 XFU 60/50/30W Knuckle



X17 XFU 60/50/30W Trunnion



X17 XFU 60/50/30W Slipfitter

### IMPORTANT

#### READ CAREFULLY BEFORE INSTALLING FIXTURE. RETAIN THESE INSTRUCTIONS FOR FUTURE REFERENCE.

RAB fixtures must be wired in accordance with the National Electrical Code and all applicable local codes. Proper grounding is required for safety. THIS PRODUCT MUST BE INSTALLED IN ACCORDANCE WITH THE APPLICABLE INSTALLATION CODE BY A PERSON FAMILIAR WITH THE CONSTRUCTION AND OPERATION OF THE PRODUCT AND THE HAZARDS INVOLVED.

**WARNING: Make certain power is OFF before installing or maintaining fixture. No user serviceable parts inside.**

**WARNING: Do not use an electric generator to test LED fixtures.**

**WARNING: Min 75°C SUPPLY CONDUCTORS.**

### KNUCKLE MOUNT

To ensure weatherproof seal, apply weatherproof silicone sealant around the edge of the junction box (*not supplied*). This is especially important with an uneven wall surface.

1. Secure the fixture to a 1/2" NPS hole in the junction box or landscape post as shown in **Fig. 1**. Seal arm thread using Teflon® tape or silicone sealant.
2. Make appropriate wire connections per NEC in an approved enclosure (*not included*) see **Fig. 7**.
3. The **Knuckle Arm** allows 180° of vertical aiming adjustment depending on the mounting position as shown in **Fig. 2**.

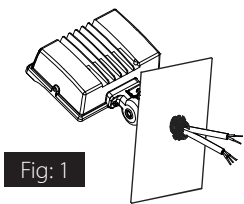

Fig. 1

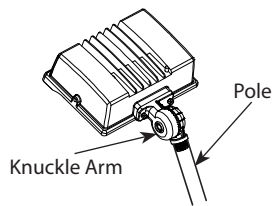

Fig. 2

### SLIPFITTER MOUNT

1. Place the **Slipfitter** over the **Tennon** and secure the **Fixture** with the **Locking Bolts (4)** on the side of the **Slipfitter** as shown in **Fig. 3**.
2. Make appropriate wire connections per NEC in an approved enclosure (*not included*) see **Fig. 7**.
3. Loosen the **Locking Bolts (4)** and swivel **Fixture** to desired angle.
4. Tighten the **Locking Bolts (4)**.

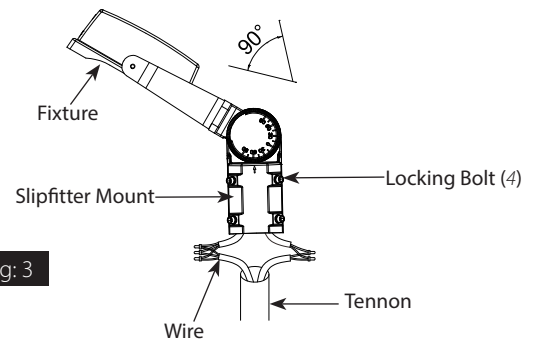

Fig. 3

### TRUNNION MOUNT

To adjust the angle of the **Fixture** using the **Trunnion** (**Fig. 4**):

1. Loosen the **Pivot Bolts** and **Angle Locking Screws**.
2. Make appropriate wire connections per NEC in an approved enclosure (*not included*) see **Fig. 7**.
3. Adjust fixture to desired angle.
4. Tighten **Pivot Bolts** and **Angle Locking Screw**.

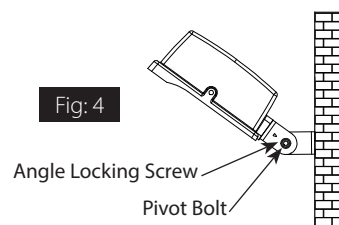

Fig. 4

# INSTRUCTIONS

## X17™ XFU 3-WAY FIELD-ADJUSTABLE FLOODLIGHT INSTALLATION



RAB Lighting is committed to creating high-quality, affordable, well-designed and energy-efficient LED lighting and controls that make it easy for electricians to install and end users to save energy. We'd love to hear your comments. Please call the Marketing Department at 888-RAB-1000 or email: [marketing@rablighting.com](mailto:marketing@rablighting.com)

### FIELD ADJUSTMENT

Follow instructions below to change fixture **Power (W)** or **Color Temperature (CCT)** from the factory settings and **Photocell On/Off** option.

Factory Settings: 4000K and 60W

1. Remove **Selector Switch Caps** by turning counterclockwise using a flat head screwdriver (Fig. 5).
2. Locate the **Selector Switches** on the fixture (Fig. 6).
3. Select **Power (W)** and **Color Temperature (CCT)** by sliding the respective switch to the desired value.
4. Select **Photocell On/Off** option by sliding respective switch to the desired value.
5. Replace **Selector Switch Caps** and tighten with a flat head screwdriver.

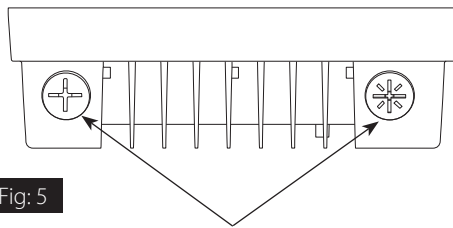

Fig: 5

Selector Switch Caps

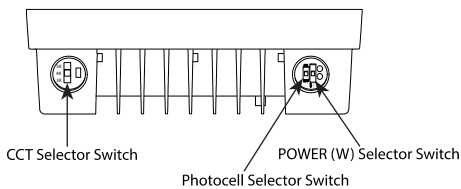

Fig: 6

**Note:** These instructions do not cover all details or variations in equipment nor do they provide for every possible situation during installation, operation or maintenance.

### 0-10V DIMMABLE WIRING

Universal voltage driver permits operation at 120V thru 277V, 50 or 60 Hz. For 0-10 Dimming, follow the wiring directions as in Fig. 7.

1. Connect the Black/Brown fixture lead to the LINE supply lead.
2. Connect the White/Blue fixture lead to the COMMON supply lead.
3. Connect the Green/Yellow wire from fixture to supply ground. Do NOT connect the GROUND of the dimming fixture to the output.
4. Connect the purple fixture lead to the DIM V+ lead.
5. Connect the gray fixture lead to the DIM V- lead.
6. Cap the yellow fixture lead, if present. Do NOT connect.

Fig: 7

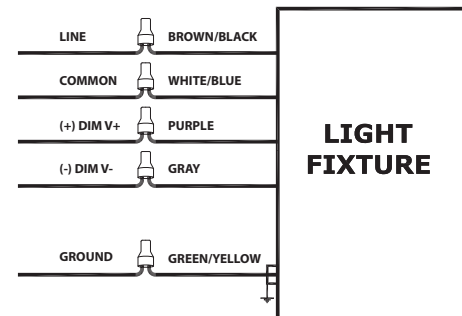

### CLEANING & MAINTENANCE

**CAUTION:** Be sure fixture temperature is cool enough to touch. Do not clean or maintain while fixture is energized.

1. Clean glass lens with non-abrasive glass cleaning solution.
2. Do not open the fixture to clean the LED. Do not touch the LED.

### TROUBLESHOOTING

1. Is the fixture grounded properly?
2. It is recommended that gloves be worn to avoid injury during installation.
3. If any smoke or spark, please turn off the power immediately.



© 2021 RAB LIGHTING Inc.  
X17 XFU 60-50-30 IN-0921  
P-100056

#### Easy Answers

[rablighting.com](http://rablighting.com)  
Visit our website for product info

Tech Help Line  
Call our experts: 888 722-1000

e-mail  
Answered promptly - [sales@rablighting.com](mailto:sales@rablighting.com)

Free Lighting Layouts  
Answered online or by request

# INSTRUCTIONS

## X17™ XFU 3-WAY FIELD ADJUSTABLE FLOODLIGHT SELECTABLE PHOTOCELL INSTALLATION



RAB Lighting is committed to creating high-quality, affordable, well-designed and energy-efficient LED lighting and controls that make it easy for electricians to install and end users to save energy. We'd love to hear your comments. Please call the Marketing Department at 888-RAB-1000 or email: marketing@rablighting.com

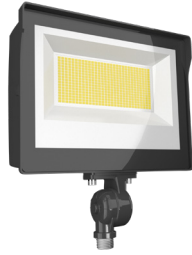

X17 XFU 80/60/40W Knuckle



X17 XFU 80/60/40W Trunnion

### IMPORTANT

#### READ CAREFULLY BEFORE INSTALLING FIXTURE. RETAIN THESE INSTRUCTIONS FOR FUTURE REFERENCE.

RAB fixtures must be wired in accordance with the National Electrical Code and all applicable local codes. Proper grounding is required for safety. THIS PRODUCT MUST BE INSTALLED IN ACCORDANCE WITH THE APPLICABLE INSTALLATION CODE BY A PERSON FAMILIAR WITH THE CONSTRUCTION AND OPERATION OF THE PRODUCT AND THE HAZARDS INVOLVED.

**WARNING: Make certain power is OFF before installing or maintaining fixture. No user serviceable parts inside.**

**WARNING: Do not use an electric generator to test LED fixtures.**

**WARNING: Min 75°C SUPPLY CONDUCTORS.**

### KNUCKLE MOUNT

To ensure weatherproof seal, apply weatherproof silicone sealant around the edge of the Junction Box (*not supplied*). This is especially important with an uneven wall surface.

1. Secure the fixture to a 1/2" NPS hole in the junction box or landscape post as shown in **Fig. 1**. Seal arm thread using Teflon® tape or silicone sealant.
2. Make appropriate wire connections per NEC in an approved enclosure (*not included*) see **Fig. 9**.
3. The **Knuckle Arm** allows 180° of vertical aiming adjustment depending on the mounting position as shown in **Fig. 2**.

Fig: 1

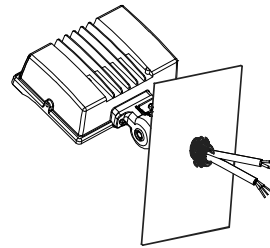

Fig: 2

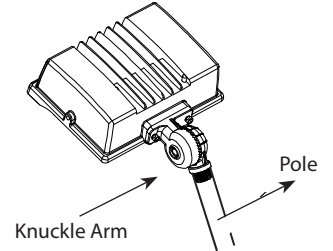

Fig: 3

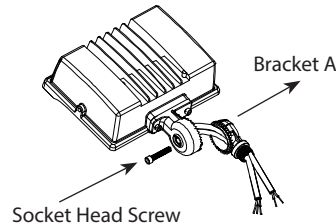
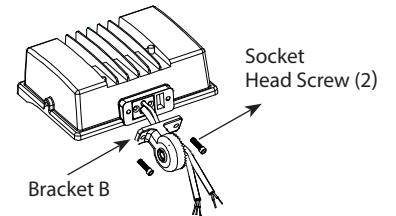

Fig: 4



### TRUNNION MOUNT

*Trunnion Mount accessory included.*

To Install the Trunnion:

1. Remove the pre-installed **Knuckle Mount** by loosening the **Socket Head Screw** and removing **Bracket A** as shown in **Fig. 3**.
2. Loosen 2 **Socket Head Screws** to remove **Bracket B** as shown in **Fig. 4**.
3. Insert **Fixture** wires through the **Trunnion** and align with **Fixture** screw holes. Secure the **Trunnion** to the **Fixture** by tightening 2 **Socket Head Screws** as shown in **Fig. 5**.

Fig: 5

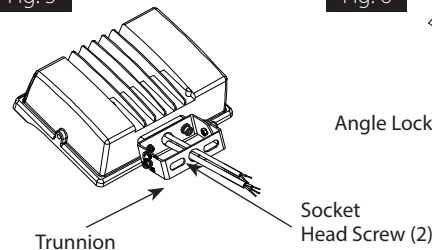
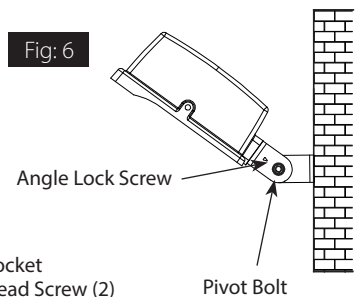

Fig: 6



# INSTRUCTIONS

## X17™ XFU 3-WAY FIELD ADJUSTABLE FLOODLIGHT SELECTABLE PHOTOCELL INSTALLATION



RAB Lighting is committed to creating high-quality, affordable, well-designed and energy-efficient LED lighting and controls that make it easy for electricians to install and end users to save energy. We'd love to hear your comments. Please call the Marketing Department at 888-RAB-1000 or email: [marketing@rablighting.com](mailto:marketing@rablighting.com)

### TRUNNION MOUNT CONT.

To adjust the angle of the fixture using the Trunnion (Fig. 6).

1. Loosen the **Pivot Bolts** and **Angle Locking Screws**.
2. Make appropriate wire connections per NEC in a approved enclosure (not included) see Fig 9.
3. Adjust **Fixture** to desired angle (Fig. 6).
4. Tighten **Pivot Bolts** and **Angle Locking Screws**.

### FIELD ADJUSTMENT

Follow instructions below to change fixture **Power (W)** or **Color Temperature (CCT)** from the factory settings and **Photocell On/Off** option.

Factory Settings: 4000K and 60W

1. Remove **Selector Switch Caps** by turning counterclockwise using a flat head screwdriver (Fig. 7).
2. Locate the **Selector Switches** on the fixture (Fig. 8).
3. Select **Power (W)** and **Color Temperature (CCT)** by sliding the respective switch to the desired value.
4. Select **Photocell On/Off** option by sliding respective switch to the desired value.

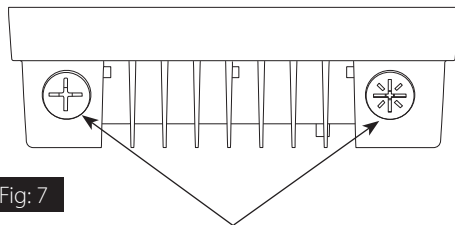

Fig: 7

Selector Switch Caps

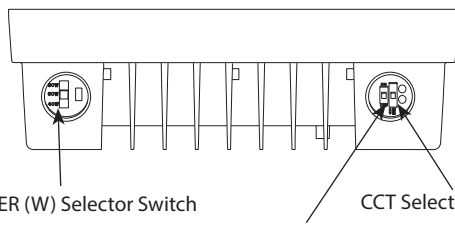

Fig: 8

POWER (W) Selector Switch

CCT Selector Switch

Photocell Selector Switch

### 0-10V DIMMABLE WIRING

Universal voltage driver permits operation at 120V thru 277V, 50 or 60 Hz. For 0-10 Dimming, follow the wiring directions as in Fig. 9.

1. Connect the Black/Brown fixture lead to the LINE supply lead.
2. Connect the White/Blue fixture lead to the COMMON supply lead.
3. Connect the Green/Yellow wire from fixture to supply ground. Do NOT connect the GROUND of the dimming fixture to the output.
4. Connect the purple fixture lead to the DIM V+ lead.
5. Connect the gray fixture lead to the DIM V- lead.
6. Cap the yellow fixture lead, if present. Do NOT connect.

Fig: 9

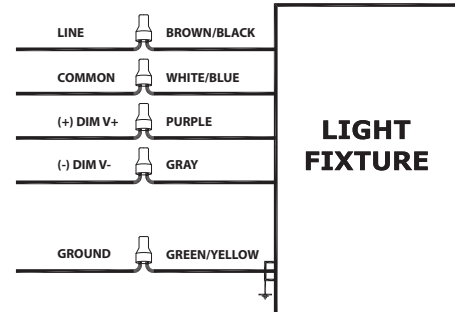

### CLEANING & MAINTENANCE

**CAUTION:** Be sure fixture temperature is cool enough to touch. Do not clean or maintain while fixture is energized.

1. Clean glass lens with non-abrasive glass cleaning solution.
2. Do not open the fixture to clean the LED. Do not touch the LED.

### TROUBLESHOOTING

1. Is the fixture grounded properly?
2. It is recommended that gloves be worn to avoid injury during installation.
3. If any smoke or spark, please turn off the power immediately.

**Note:** These instructions do not cover all details or variations in equipment nor do they provide for every possible situation during installation, operation or maintenance.



© 2021 RAB LIGHTING Inc.  
X17 XFU 80-60-40 IN-0921  
73710-RAB

#### Easy Answers

[rablighting.com](http://rablighting.com)  
Visit our website for product info

Tech Help Line  
Call our experts: 888 722-1000

e-mail  
Answered promptly - [sales@rablighting.com](mailto:sales@rablighting.com)

Free Lighting Layouts  
Answered online or by request