

Put all your savings
into one basket.

SWISH® LED Center Basket



RAB® | Indoor

RABLIGHTING.COM • 888 722-1000



LED Center Basket

- Available in 2x2 (19 & 29W) and 2x4 (39 & 49W)
- Ultra-high efficiency, up to 135 lm/W
- 0-10V dimming standard on all models
- Emergency battery backup available
- Optional occupancy sensor or Lightcloud® Controller
- Chicago Plenum (CCEA) compliant models
- 100,000-hour LED lifespan



RAB's warranty is subject to all terms and conditions found at rablighting.com/warranty



Visit rablighting.com to see which models are DLC or DLC Premium listed.



See the difference.

Frosted polycarbonate lens with proprietary diffusion design provides uniform distribution and reduces glare.



Durable build.

Die-formed 20 gauge, cold-rolled steel with high-reflectance (91%) powder-coated white finish.



Smart sensing.

Programmable occupancy sensor for multi-level lighting control. Includes manual override from a light switch.

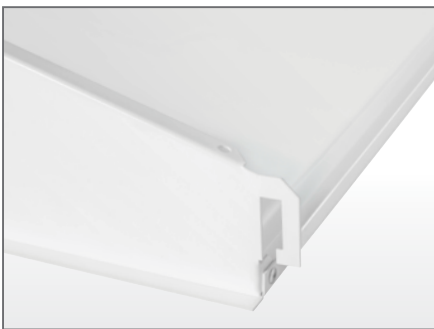

Engineered to a tee.

Standard integral clips secure troffer to T-bars and don't get lost during installation.

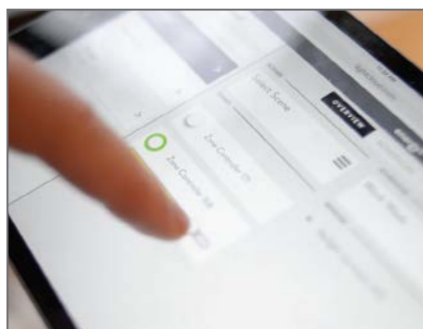

Controls made simple.

Optional, factory-installed Lightcloud Controller for use with RAB's Lightcloud lighting control system.



Wide open spaces.

Wide distribution pattern allows for wide spacing and uniform lighting on the work plane.

Photometrics

SWISH2X2-19N/D10: 2x2 - 19W - 4000K - 0-10V Dimming (Photometric Report #RAB01863)

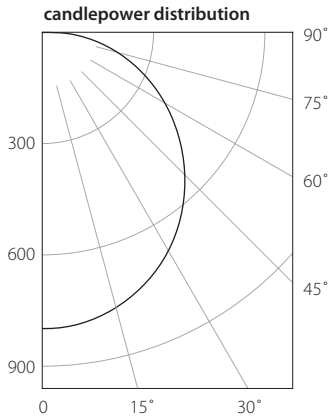

candela distribution

vertical deg.	0.0	22.5	45.0	67.5	90.0
0	797	797	797	797	797
5	793	793	795	797	798
15	762	764	767	772	773
25	705	707	714	721	724
35	625	628	638	649	655
45	524	529	542	558	566
55	408	416	435	458	469
65	288	300	328	358	371
75	163	177	210	243	262
85	48	62	81	89	95
90	2	2	1	2	2

zonal lumen summary

zone	lumens	% fix.
0- 30	622	25.3
0- 40	1021	41.5
0- 60	1832	74.4
0- 90	2461	100.0
90-180	0	0.0
0-180	2461	100.0

luminance (cd/M²)

avg. luminance			
angle	0°	45°	90°
45	2161	2235	2334
55	2074	2212	2385
65	1987	2263	2560
75	1837	2366	2952
85	1606	2710	3179

Replaces:
(2) F17 T8 or (2) F24 T5

Efficacy: 126 lm/W

spacing criteria

0° - 180°	90° - 270°	Diag.
1.2	1.3	1.4

SWISH2X2-29N/D10: 2x2 - 29W - 4000K - 0-10V Dimming (Photometric Report #RAB01841)

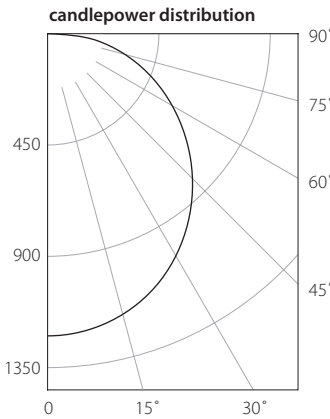

candela distribution

vertical deg.	0.0	22.5	45.0	67.5	90.0
0	1224	1224	1224	1224	1224
5	1216	1216	1219	1222	1223
15	1169	1171	1177	1184	1186
25	1080	1085	1094	1107	1111
35	953	962	976	995	1001
45	799	809	829	855	865
55	625	635	663	701	718
65	438	454	497	543	564
75	252	274	323	373	401
85	74	96	127	138	143
90	4	4	4	3	3

zonal lumen summary

zone	lumens	% fix.
0- 30	953	25.3
0- 40	1565	41.6
0- 60	2804	74.5
0- 90	3765	100.0
90-180	0	0.0
0-180	3765	100.0

luminance (cd/M²)

avg. luminance			
angle	0°	45°	90°
45	3310	3434	3583
55	3192	3386	3667
65	3036	3445	3909
75	2852	3655	4538
85	2487	4268	4806

Replaces:
(3) F17 T8 or (3) F14 T5

Efficacy: 129 lm/W

spacing criteria

0° - 180°	90° - 270°	Diag.
1.2	1.3	1.4

SWISH2X4-39N/D10: 2x4 - 39W - 4000K - 0-10V Dimming (Photometric Report #RAB01861)

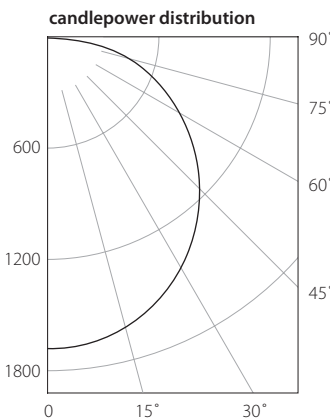

candela distribution

vertical deg.	0.0	22.5	45.0	67.5	90.0
0	1676	1676	1676	1676	1676
5	1645	1655	1677	1682	1681
15	1589	1598	1621	1629	1632
25	1477	1489	1513	1526	1531
35	1316	1330	1357	1375	1383
45	1111	1128	1157	1187	1196
55	877	895	932	973	989
65	616	640	696	751	770
75	355	391	454	508	533
85	106	147	185	203	203
90	6	7	5	6	6

zonal lumen summary

zone	lumens	% fix.
0- 30	1310	25.1
0- 40	2156	41.3
0- 60	3884	74.3
0- 90	5227	100.0
90-180	0	0.0
0-180	5227	100.0

luminance (cd/M²)

avg. luminance			
angle	0°	45°	90°
45	2246	2339	2418
55	2186	2323	2465
65	2084	2354	2605
75	1961	2508	2944
85	1739	3035	3330

Replaces:
(2) F32 T8 or (2) F28 T5

Efficacy: 135 lm/W

spacing criteria

0° - 180°	90° - 270°	Diag.
1.2	1.3	1.4

SWISH2X4-49N/D10: 2x4 - 49W - 4000K - 0-10V Dimming (Photometric Report #RAB01859)

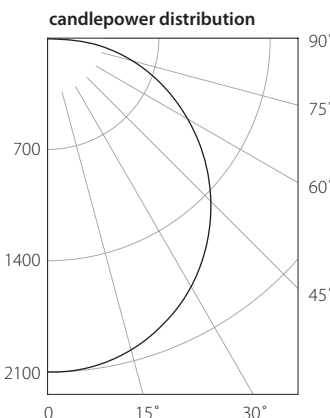

candela distribution

vertical deg.	0.0	22.5	45.0	67.5	90.0
0	2086	2086	2086	2086	2086
5	2049	2061	2087	2095	2093
15	1978	1990	2019	2029	2033
25	1839	1854	1885	1900	1906
35	1637	1658	1693	1713	1724
45	1387	1407	1447	1478	1492
55	1098	1118	1167	1214	1237
65	776	802	873	938	960
75	448	485	562	632	666
85	135	183	238	256	260
90	7	8	6	5	5

zonal lumen summary

zone	lumens	% fix.
0- 30	1631	25.0
0- 40	2686	41.2
0- 60	4843	74.2
0- 90	6523	100.0
90-180	0	0.0
0-180	6523	100.0

luminance (cd/M²)

avg. luminance			
angle	0°	45°	90°
45	2804	2926	3017
55	2737	2909	3083
65	2625	2953	3248
75	2475	3104	3679
85	2475	3104	3679

Replaces:
(3) F32 T8 or (3) F28 T5

Efficacy: 134 lm/W

spacing criteria

0° - 180°	90° - 270°	Diag.
1.2	1.3	1.4

Specifications

UL Listing: Suitable for damp locations

IC Rating: Suitable for direct contact with insulation

CCEA: CCEA-compliant models available. City of Chicago Environmental Air Luminaire Requirements used in Environmental Air Space per the electrical code specification of the City of Chicago.

LEDs: Long-life, high-efficacy, surface-mount LEDs

Lifespan: 100,000-hour LED lifespan based on IES LM-80 results and TM-21 calculations

Drivers: Class 2, Constant Current, 100-277V, 50/60Hz, THD <15%, Power Factor >90%

19W: 0.16A @ 120V; 0.10A @ 208V; 0.09A @ 240V; 0.08A @ 277V

29W: 0.24A @ 120V; 0.15A @ 208V; 0.13A @ 240V; 0.11A @ 277V

39W: 0.33A @ 120V; 0.20A @ 208V; 0.17A @ 240V; 0.15A @ 277V

49W: 0.41A @ 120V; 0.24A @ 208V; 0.21A @ 240V; 0.18A @ 277V

Dimming: 0 - 10V dimmable driver, standard

5000K	2 x 2 SWISH		2 x 4 SWISH	
	19W	29W	39W	49W
Nominal Watts @120V	18	30	38	52
Input Watts	2878	4037	5619	7289
Output Lumens	158	133	146	140
Lumens Per Watt	85	85	85	85
Color Accuracy (CRI)				
4000K	2 x 2 SWISH		2 x 4 SWISH	
	19W	29W	39W	49W
Nominal Watts @120V	18	30	38	51
Input Watts	2776	4039	5436	7187
Output Lumens	152	135	145	142
Lumens Per Watt	85	85	85	85
Color Accuracy (CRI)				
3500K	2 x 2 SWISH		2 x 4 SWISH	
	19W	29W	39W	49W
Input Watts	2676	4114	5334	7340
Output Lumens	144	137	142	145
Lumens Per Watt	83	83	83	83
Color Accuracy (CRI)				
3000K	2 x 2 SWISH		2 x 4 SWISH	
	19W	29W	39W	49W
Input Watts	2533	3894	5125	7052
Output Lumens	135	128	135	138
Lumens Per Watt	83	84	84	82
Color Accuracy (CRI)				

Ambient Temperature: Suitable for use in 40°C ambient temperatures

Housing: Die-formed, 20-gauge, cold-rolled steel

Mounting: Integral T-grid clips make installation easy and secure

Reflector: High-reflectance, powder-coated finish, optimized for uniform distribution

Lens: Snap-in, frosted polycarbonate lens

Color Stability: LED color temperature is warranted to shift no more than 200K in CCT over a 5 year period.

Color Uniformity: RAB's range of CCT (Correlated Color Temperature) follows the guidelines of the American National Standard for Specifications for the Chromaticity of Solid State Lighting (SSL) Products, ANSI C78.377-2017.

Green Technology: Mercury and UV free. RoHS-compliant components.

Dimensions and weight

2x2

Weight: 14 lbs

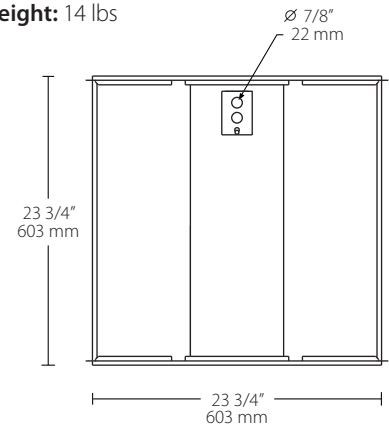

2x4

Weight: 23 lbs

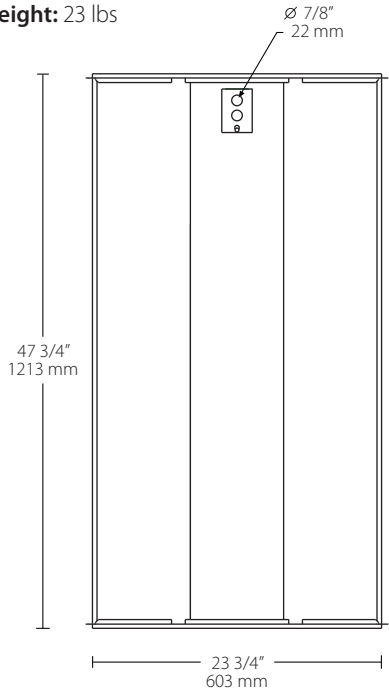

Accessories

Recessed Drywall Mounting Kits

RMKPANEL2X2 - 2x2 Kit (shown)

RMKPANEL2X4 - 2x4 Kit



Surface Mount Kits

SMKPANEL2X2 - 2x2 Kit (shown)

SMKPANEL2X4 - 2x4 Kit



Ordering information

Product Family	Size	Wattage	Color Temp.	Driver	Options	Chicago Plenum
SWISH	2X2 2' x 2' 2X4 2' x 4'	19 19W (2x2) 29 29W (2x2) 39 39W (2x4) 49 49W (2x4)	Blank 5000K N 4000K YN 3500K Y 3000K	/D10 0-10V Dimming, 120-277V	/E2 Emergency Battery Backup /LC Lightcloud Controller /MVS Occupancy Sensor /MVS/E2 Occupancy Sensor + Emergency Battery Backup	/CP