

NDLED7 INSTALLATION INSTRUCTIONS

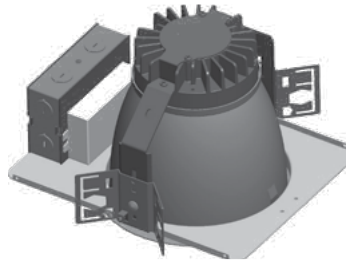

Thank you for buying RAB lighting fixtures. Our goal is to design the best quality products to get the job done right. We'd like to hear your comments. Call the Marketing Department at 888-RAB-1000 or email: marketing@rabweb.com



NDLED7
Cut-Out Diameter: 7-3/4"

IMPORTANT

READ CAREFULLY BEFORE INSTALLING FIXTURE. RETAIN THESE INSTRUCTIONS FOR FUTURE REFERENCE.

RAB fixtures must be wired in accordance with the National Electrical Code and all applicable local codes. Proper grounding is required for safety. THIS PRODUCT MUST BE INSTALLED IN ACCORDANCE WITH THE APPLICABLE INSTALLATION CODE BY A PERSON FAMILIAR WITH THE CONSTRUCTION AND OPERATION OF THE PRODUCT AND THE HAZARDS INVOLVED.

WARNING: Make certain power is OFF before installing or maintaining fixture. No user serviceable parts inside.

WARNING: Suitable for wet locations and covered ceiling mount only - where the ambient temperature is 0°C minimum, +40°C maximum.

WARNING: Suitable for installation in Non-Accessible and Accessible Ceilings.

WARNING: Suitable for installation in Non-Insulated Ceilings only.

WARNING: Do not install insulation within 76 mm (3 in) of any part of the Luminaire.

MOUNTING BARS

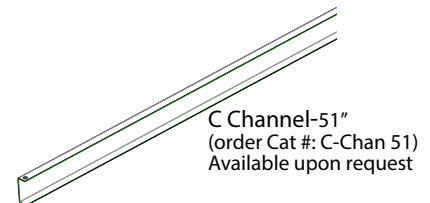
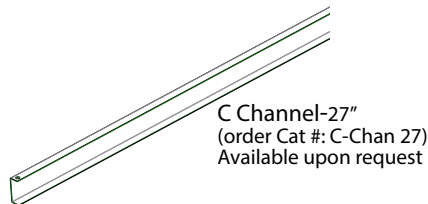
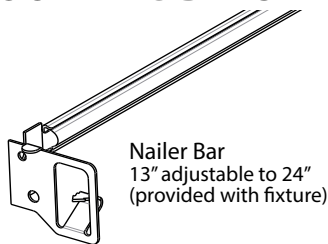

ROUGH-IN MOUNTING

1. Nailer bars are provided for use with wood joist installations. Insert through **Nailer Bar Slots** in **Butterfly Brackets** and secure accordingly. C-Channels are optionally available, consult factory. Consult local building codes for final support of fixture.
2. Remove appropriate **Knock out** on **Junction box**. Press **Clip** to open the **Junction Box**.
3. Use appropriate UL approved wire connectors as required by code to complete wiring between conduit whip and with supply wires. Be careful not to pinch wires.
WARNING: To prevent wiring damage or abrasion, do not expose wiring to edges of sharp objects.
4. The fixture can be adjusted to different heights above the ceiling surface. For height adjustment, loosen the **Wing Nut** and slide the **Butterfly Bracket**. If necessary remove the **Wing Nut** and insert in screw in different hole provided on the **Butterfly Bracket** as shown in **Fig. 2**.
5. Adjust both the **Butterfly Brackets** such that the frame of **Rough-In Section** is flush with the finished ceiling surface. Tighten the **Wing Nuts**.

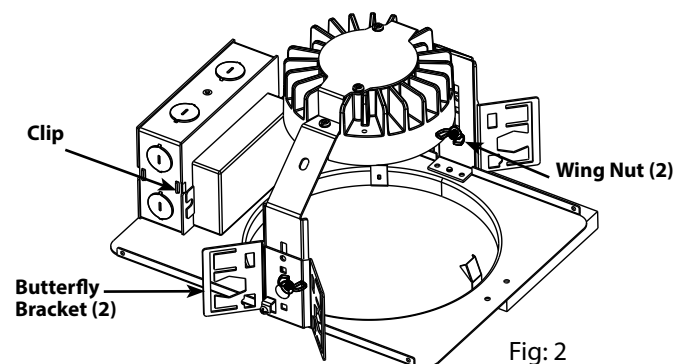
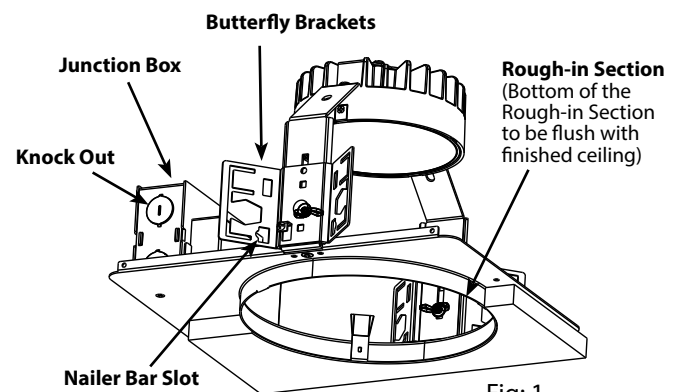

NDLED7 INSTALLATION INSTRUCTIONS

Thank you for buying RAB lighting fixtures. Our goal is to design the best quality products to get the job done right. We'd like to hear your comments. Call the Marketing Department at 888-RAB-1000 or email: marketing@rabweb.com

TRIM CONE MOUNTING

Gently push **Trim Cone** in the **Rough-In Section** as shown in **Fig. 3**. **Jam Clips (3)** will hold the **Trim Cone** in place.

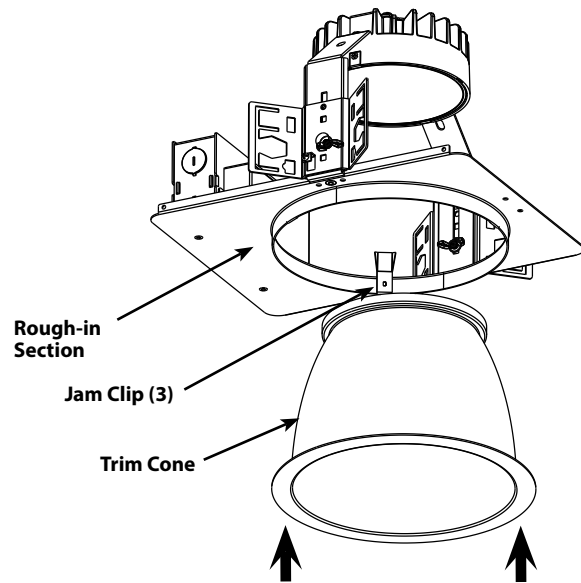

Fig: 3

WIRING

RISK OF FIRE. Universal voltage driver permits operation at 120V thru 277V, 50 or 60 Hz.

For **Non-Dimming, Electronic Low Voltage (ELV) and Triac Dimming**, follow wiring direction in **Fig. 4**.

1. Connect the black fixture lead to the LINE supply lead.
2. Connect the white fixture lead to the COMMON supply lead.
3. Connect the GROUND wire from fixture to supply ground. Do NOT connect the GROUND of the dimming fixture to the output.
4. Cap purple, gray and yellow leads. Do NOT connect.

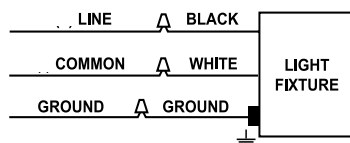

Fig: 4

For **0-10V Dimming**, follow the wiring directions as shown below in **Fig. 5**. 0-10V control wires must be rated for 300V minimum.

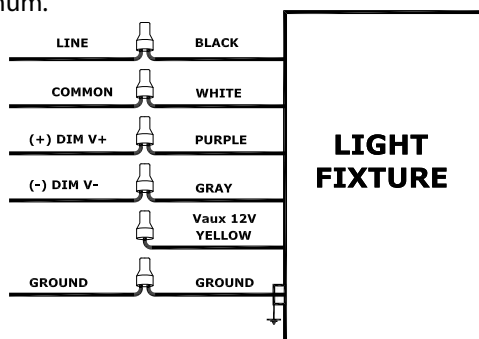

Fig: 5

Note: These instructions do not cover all details or variations in equipment nor do they provide for every possible situation during installation operation or maintenance.

Easy Installation & Product Help

Tech Help Line
Call our experts 888 RAB-1000

rabweb.com
Visit our website for product info

email
Answered promptly sales@rabweb.com

TROUBLESHOOTING

1. Check that the line voltage at the fixture is correct. Refer to wiring directions.
2. Be sure the fixture is grounded properly.
3. For questions on compatibility of dimmers purchased separately refer to www.rabweb.com
4. If the LED is blinking the fixture may be overheating. Remove the Trim assembly and if the fixture is labeled 'BLINKING LIGHT OF THIS THERMALLY PROTECTED LUMINAIRE MAY INDICATE OVERHEATING' allow the fixture to cool down. Determine cause of overheating and remove. Fixtures with this label have a thermal protector that turns fixture off above a certain temperature. It will automatically restart when cool.

CLEANING & MAINTENANCE

CAUTION: Be sure fixture temperature is cool enough to touch. Do not clean or maintain while fixture is energized.

1. Do not open fixture to clean the LED. Do not touch the LED.
2. Do not touch lens, or trim cone.
3. Do not clean any fixture surface with wood base cleaning material such as paper towels or tissues. Only use micro fiber cleaning cloth.

NDLED7 INSTALLATION INSTRUCTIONS



Thank you for buying RAB lighting fixtures. Our goal is to design the best quality products to get the job done right. We'd like to hear your comments. Call the Marketing Department at 888-RAB-1000 or email: marketing@rabweb.com

DIMENSIONAL DRAWING

